



METER

SATURO



TABLE OF CONTENTS

1. Introduction	1
2. Operation	2
2.1 Installation	2
2.2 Configuring a Test	8
2.3 Starting a Test	11
2.4 Stopping a Test	13
2.5 Charging	13
2.6 Downloading Data	14
3. System	16
3.1 Specifications	16
3.2 Components	17
3.2.1 Control Unit	18
3.2.2 Insertion Ring	25
3.2.3 Infiltrometer Head	26
3.2.4 Water Supply Tank	26
3.2.5 Borehole infiltrometer head	27
3.3 Theory	27
4. Service	31
4.1 Calibration	31
4.2 Maintenance	33
4.3 Troubleshooting	34
4.4 Customer Support	37
4.5 Terms and Conditions	37

References	38
Index	39

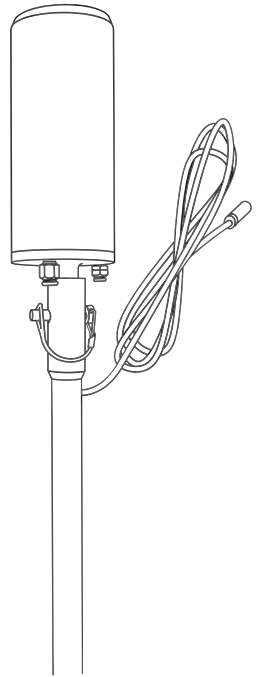
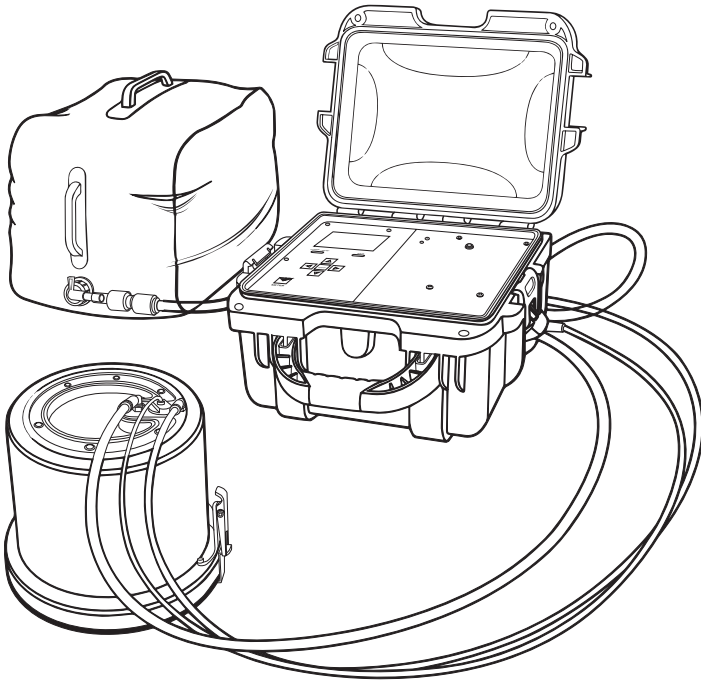

1. INTRODUCTION

Thank you for choosing the SATURO Infiltrometer from METER Group. This manual outlines the functionality of SATURO, make high-quality K_{fs} measurements, and get the most out of the instrument.

SATURO was designed to be an automated instrument for measuring permeability and field saturated hydraulic conductivity (K_{fs}) in soil. It utilizes a multipressure head analysis approach to simplify the corrections for three-dimensional flow from a single-ring infiltrometer, allowing for quick measurements of hydraulic conductivity without needing postprocessing. This automated approach reduces error in the hydraulic conductivity assessment (Reynold and Elrick 1990).

Verify all instrument parts and equipment were shipped and appear in good condition:

- Control unit
- Two insertion rings: 5-cm depth and 10-cm depth
- Driving plate
- Infiltrometer head
- Charging adapter
- Two collapsible water tanks
- 6.4-mm (1/4-in) diameter tube for air output
- 9.5-mm (3/8-in) diameter tube for water output
- 7.9-mm (5/16-in) diameter tube for water input
- Metal file
- Driving mallet
- Flathead screwdriver
- 24-in foam gasket for infiltrometer head

Optional SATURO Borehole accessory kit:

- Borehole infiltrometer head
- 10-cm (4-in) hex quick pin
- 2 x 1-m (3-ft) extention rod w/ hex quick pin
- Slide hammer w/ hex quick pin
- Auger handle w/ hex quick pin
- 10-cm (4-in) finishing auger w/hex quick pin
- Two 3/8-in x 1 3/4-in pins

2. OPERATION

Please read all instructions before operating the SATURO to ensure it performs to its full potential.

2.1 INSTALLATION

Follow the steps listed in [Table 1](#) to set up the instrument.

Table 1 Installation

Tools Needed	Hammer
Preparation	<p>Verify Access to Water Identify a source of water on site or bring water to the site.</p> <p>Charge Battery Charge the control unit battery. Renew the charge after returning from the field.</p> <p>Download Software Install the SATURO Downloader to view files in the field (Section 2.6).</p> <p>Install Insertion Ring Remove rocks, sticks, and other large debris from the surface where the ring will be installed at the desired test location. Place the insertion ring on the soil and fit the driving plate on top. Hammer on the inner circle of the driving plate until the insertion ring is flush with the top of the soil, ensuring there are no gaps between the soil and ring side walls. Remove the driving plate.</p>
Installation	<p>For hill installation, install the insertion ring so that the infiltrometer head will be perpendicular to the slope of the hill with interior sensor to the left or right.</p> 

Table 1 Installation (continued)

Set Up Infiltrometer Head

Remove tag from bottom of infiltrometer head and insert 24-in foam gasket into groove. Ensure that foam is fully seated in groove and ends fit together snugly. There should not be a large gap between the ends of the gasket once seated.

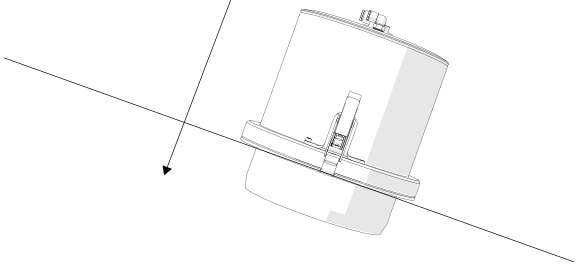
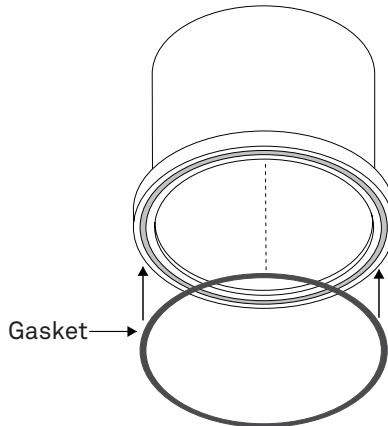

Installation
(continued)

⚠ WARNING

Do not use sharp objects to seat gasket. Holes will allow water to leak out of the pressure chamber, causing inaccurate measurement

Clear all grass and debris from the lip of the insertion ring and clamp the infiltrometer head onto the insertion ring to form a seal.

A clean seal ensures accurate pressure readings. Do not clamp too tightly, as this can lead to warping the insertion ring. Clamps can be tightened and loosened with a small flat head screwdriver as needed.

Connect the hoses and sensor cable to the designated fittings on the infiltrometer head. Each input and output line is purposefully a different size of tubing to help prevent a mismatch. If a tube does not snugly fit into a connection, it is probably in the wrong one.

Set Up the Water Tank

Fill the water tank and connect it to the control unit.

Fully open the water valve.

For highly permeable soil use the second collapsible bag with the Y-connector to supply 10 gal (37.8 liters) of water to the control unit. If 10 gal (37.8 liters) is not enough a larger container can be used. To use a larger container, place the tube at the bottom of the container and ensure the tube remains underwater throughout the test.

Table 1 Installation (continued)**Set Up Control Unit**

Place the control unit on a stable surface.

Connect the three hoses and sensor cable to the corresponding ports on the control unit.

For the borehole unit, connect one end of the 4 meter length of air tubing to the infiltrrometer head, and the other end to the 1L buffer bottle using the provided silicone stretch tubing. Connect one end of the 1 meter length of air tubing to the control unit, and the other end to the buffer bottle, using the provided silicone stretch tubing.



Installation
(continued)

Power on the control unit.

NOTE: After each test, clean the infiltrrometer head seals and insertion ring ([Section 4.2](#)).

Table 2 Optional Borehole Installation

Preparation

Auger Hole

Auger hole using 10 cm (4 in) auger to desired measurement depth. Leave the last 5 cm for finishing auger.

Finish hole

Use the finishing auger to the final 5 cm to the installation depth. This should leave a flat surface for installing the infiltrometer head.

Set Up Introfiltrometer Head

Connect the water line tubing and the air tubing to the introfiltrometer head.

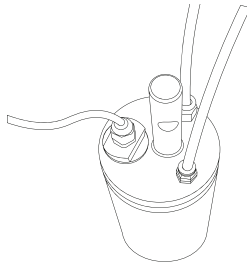

Installation

Set Up Extension Rod

Connect extension rod to infiltrometer head with connecting pin.

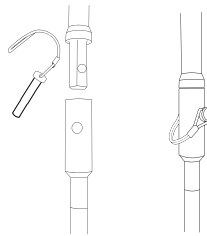

OPERATION

Table 2 Borehole Installation (continued)

Connect the slide hammer to the extension rod with the provided hex pin.

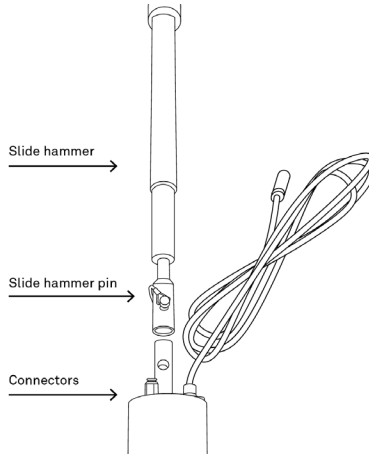

NOTE: If the installation depth is deeper than 1 m you will need to add an additional extension.

Lower the assembled extension rod with infiltrometer head into augured hole until the auger is sitting at the bottom of the augured hole.

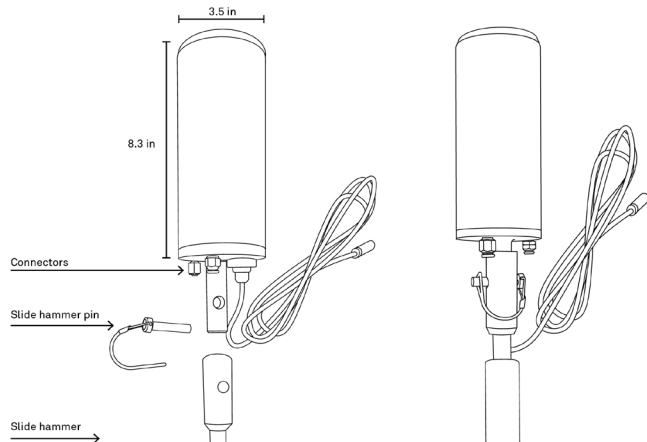

Installation
(continued)

Table 2 Borehole Installation (continued)

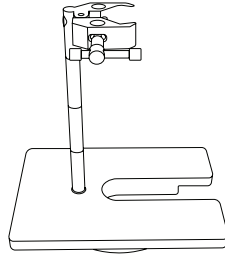

Install the installation depth and centering tool to the extension rod at the top of the augured hole. Ensure it is flush with the surface and the installation depth indicator is fully extended.

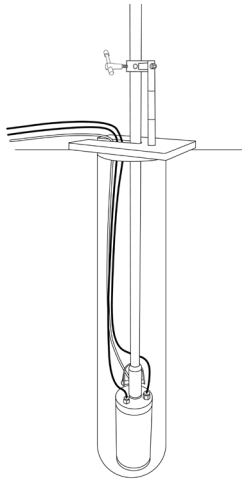

Installation
(continued)

Use the drop hammer to carefully insert the ring infiltrometer head into the soil. Ensure the assembly stays vertical during installation and limit side to side movement.

Let the weight of the hammer drive the ring into the soil. **Do not use additional force to drive the ring into the soil.**

Once the ring is driven into the soil 5 cm as indicated by the installation depth indicator stop and remove the slide hammer from the assembly.

NOTE: Do not drive the ring in deeper than the 5 cm depth. Doing so could cause errors in the water level readings that could cause the chamber to overflow with water. If the ring is driven beyond the 5 cm depth remove ring and check the level sensor to make sure it is clean.

2.2 CONFIGURING A TEST

1. Press the **POWER/MENU** button on the control unit to power on the device.
The last test results will appear on the screen.
2. Press **Enter** to view the Test Setup screen
This screen is used to name the test and configure test settings (Figure 1).



Figure 1 Test Setup screen

3. Name the test.
 - a. Select **Name** to create a test name.
 - b. Highlight letters and press **Enter** after each one (Figure 2).
A decimal point is not allowed as the first character of a test name.
Toggle between upper and lower case by selecting the boxed up arrow in the lower right of the screen.
To add a space or delete a character, navigate to the test name and use the **RIGHT** or **LEFT** buttons, respectively.
The test name can have up to 20 characters.

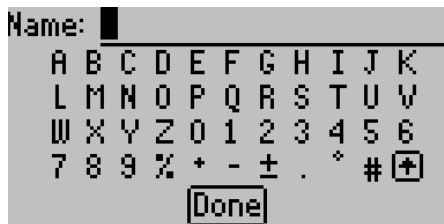

Figure 2 Name screen

4. Select **Done** and press **Enter** to save the new test name.
Press **BACK** to cancel without saving changes.

NOTE: When downloading tests as a comma-separated value file format (.csv), the degree symbol and \pm symbol are omitted from the test name in the test summary information.

5. Configure test settings by selecting **Settings**.

Different soil types may require different parameters for an optimum infiltration test. Adjust settings to change pressure heads, soak time, number of cycles, and hold time as well as to inform the control unit of the insertion ring depth (Figure 3).

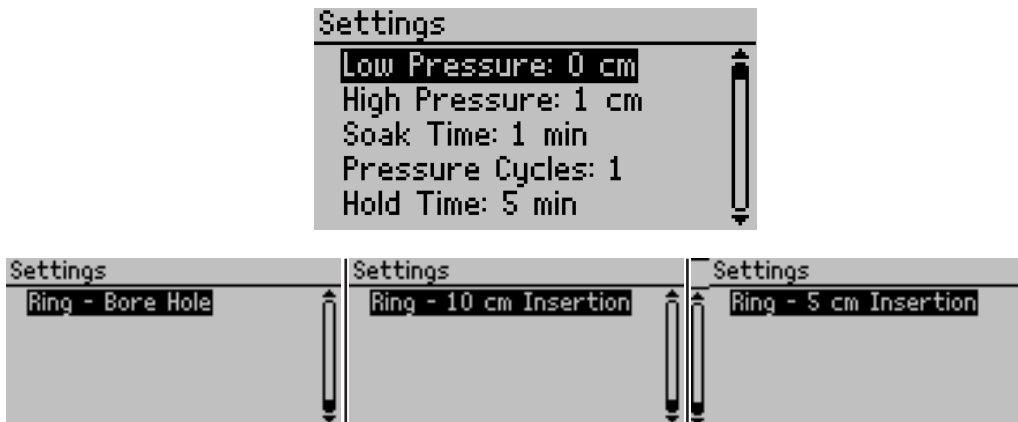

Figure 3 Settings options

- a. Set desired hydrostatic pressure.

Hydrostatic pressure for the low and high pressure heads must be between 0 and 40 cm. Generally, soils with high infiltration rates require lower pressure head settings than soils with low infiltration rates. A pressure difference of at least 5 cm between the low and high pressure heads is normally recommended, except in sites with high infiltration rates. In such cases, a pressure difference of 2 cm is sufficient to help reduce water usage. Table 3 provides rough guidelines to determine initial pressure head settings. These values are starting points only and should be adjusted for the particular soil based on experience.

- b. Set soak time.

During soak time, the infiltrometer applies water to achieve saturation of the soil before beginning the pressure cycles. A good introductory soak time is approximately 20 min, though the exact length depends largely on soil type and antecedent soil moisture (Table 3). During soak time, pressure is maintained at the low pressure head.

Table 3 Soak time and pressure head configurations

Soil Type	Soak Time (min)	Low Pressure Head (cm)	High Pressure Head (cm)	Hold Time at Pressure (min)	Pressure Cycles (count)	Total Run Time (min)
Dry loamy sand	25	5	10	15	3	115

Table 3 Soak time and pressure head configurations

Soil Type	Soak Time (min)	Low Pressure Head (cm)	High Pressure Head (cm)	Hold Time at Pressure (min)	Pressure Cycles (count)	Total Run Time (min)
Wet loamy sand	15	5	10	15	2	75
Dry silt loam	30	5	15	20	3	150
Wet silt loam	15	5	15	20	2	95
Dry clay (poor structure)	30	5	20	25	3	180
Wet clay (poor structure)	15	5	20	25	2	115
Dry clay (strong structure)	25	5	10	20	3	145

NOTE: These values are a rough starting point only. Soil conditions dictate the optimal settings for the test. Use lower pressure head settings for soils dominated by macropore flow. If necessary, reduce the pressure head settings to allow the instrument to keep up with the flow rates.

- c. Set the number of pressure cycles.

One pressure cycle is equivalent to a full run at the two different pressure heads. The control unit takes the average infiltration rates at the different pressure heads during the last pressure cycle to calculate K_{fs} . Multiple pressure cycles ensure the steady state infiltration rate was reached.

At first, the infiltration rate is large. Steady state or quasi-steady state may be achieved when the infiltration rate charted over time levels into infinite time (Dane and Topp 2002). Wait for the flux chart to stabilize to determine if quasi-steady state has been reached. If there is a decrease in flux rate, redo the test or add another cycle.

- d. Set the hold time (Figure 4).

The hold time determines how long the pressure is held at each pressure head and applies to both pressure cycles (i.e., if the hold time is 20, both the low and high pressure holds for 20 min).

- e. Select the correct insertion ring depth.

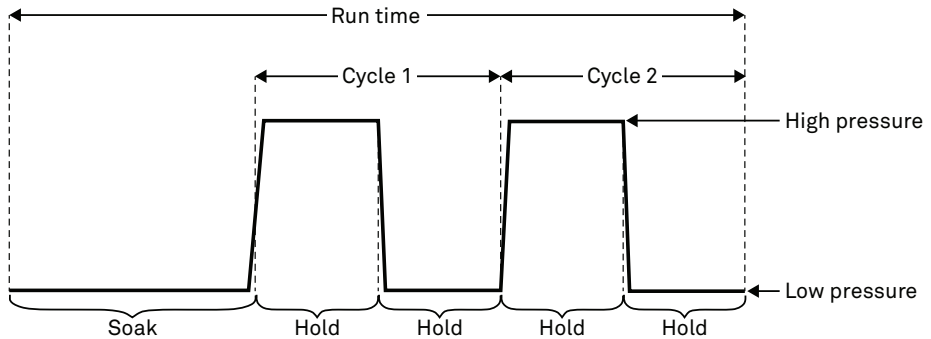

Figure 4 Run time diagram

- After the settings are configured, press **BACK** to go to the Test Setup screen.

2.3 STARTING A TEST

- On the Test Setup screen, select **Start**.

The infiltrrometer displays a message to check tubing and connections.

- Press **Enter** to begin the test.

The infiltrrometer will pump water from the water tank until the water level reaches 5 cm. It then begins the soak time, while maintaining a level of 5 cm.

The graph feature displays incremental data during a test. The infiltrrometer records a data point every minute throughout the duration of the test.

- It is not necessary to supervise the system during a test, but check the water level intermittently to ensure a constant supply.

Test results will display automatically at the end of the test (Figure 5).

NOTE: See [Section 3.2.1](#) for details on viewing graphs of flux, water level, and pressure.

2.4 STOPPING A TEST

To stop a test, press **BACK** on any of the Reading screens and select **Stop** to cancel the test (Figure 6).

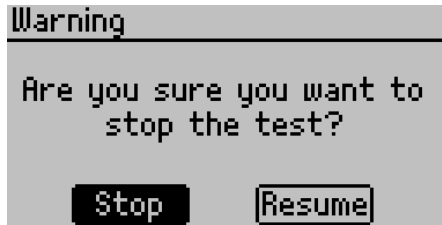

Figure 6 Stop test warning

2.5 CHARGING

The charge port for the SATURO is located on the control unit faceplate (Figure 7). The unit charger comes with both an American plug and a European plug.

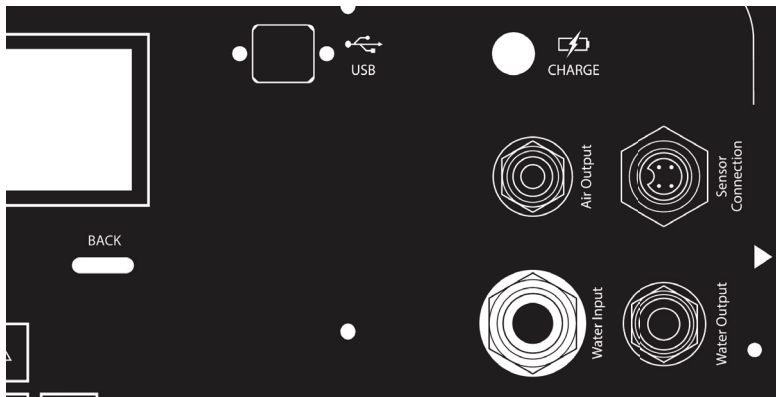

Figure 7 Charging port

To charge the SATURO connect the supplied 18-V charger. The unit may take 8-12 hours to fully charge. The SATURO will display a charging screen with a timer showing showing how long until the unit is 100% fully charged (Figure 8).

Time Remaining: 05:26



Figure 8 Charging timer screen

If the charger is unplugged before the timer indicates the device is fully charged, the SATURO will not be fully charged. The timer will complete to indicate the unit is fully charged (Figure 9).

Charge Complete!



Figure 9 Charging complete screen

The SATURO's battery may last several days. However it is highly recommended that the unit be charged after each field visit. If the unit's charger is damaged or lost contact [Customer Support](#).

2.6 DOWNLOADING DATA

The SATURO Downloader application is used to download the data from SATURO, erase stored data, set the date and time, and check for firmware updates for SATURO. Download the application from metergroup.com/saturo-support before beginning the following steps.

1. Connect the USB cable to USB ports on a computer and on SATURO.
2. Open the SATURO Downloader application on the computer.
3. Select the file type by selecting **Edit > Preferences > Data File** and choosing the appropriate file type (Figure 10).

Data can be downloaded as .xlsx or .csv file.

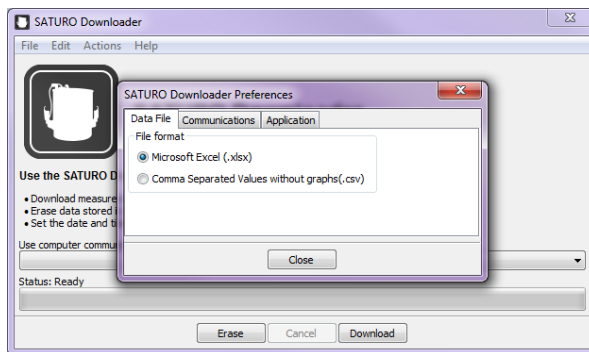

Figure 10 Change file type

- Select the proper COM port and click **Download** (Figure 11).



Figure 11 SATURO Downloader dialog

- After the download is complete, a prompt will ask if the data stored on the device should be erased (Figure 12).

Select **Yes** or **No**.

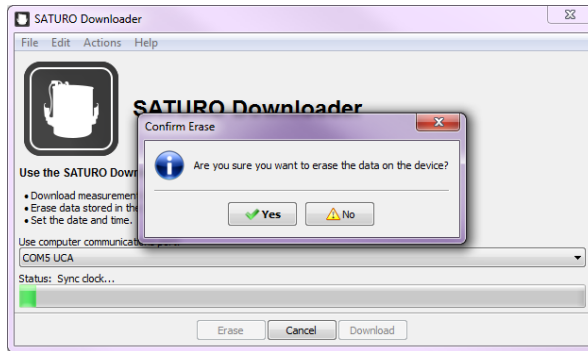

Figure 12 Confirm Erase prompt

3. SYSTEM

This section describes the specifications, components, and theory of the SATURO system.

3.1 SPECIFICATIONS

MEASUREMENT SPECIFICATIONS

Infiltration Rate

Range	0.0038–115.0000 cm/h
Resolution	0.0038 cm/h
Accuracy	±5% of reading

K_{fs}

The K_{fs} values that can be effectively measured by SATURO are limited by the listed minimum and maximum infiltration rates. These depend on the pressure heads applied to the water during infiltration and to the three-dimensional flow characteristics of the soil, so the measurement range of K_{fs} cannot be specified explicitly. SATURO will generally be able to make measurements on poorly to moderately structured soils as coarse as medium sand, but the maximum infiltration rate can be exceeded by soils with excessive structure and especially by soils with significant macropores.

Water Level

Maintained at 5 cm

Pressure Head Ranges

0–40 cm (vacuum is applied for <5 cm settings)

Operating Temperature

0–50 °C

PHYSICAL SPECIFICATIONS

Charging Adapter

Power supply	18 V; 2.2 A
Range	18–24 VDC

Output

USB

Control Unit

SATURO

Length	31.8 cm (12.5 in)
Width	25.7 cm (10.1 in)
Height	13 cm (6.0 in)

Infiltrometer Head

Total height	18.3 cm (7.2 in)
Inner diameter	17.2 cm (6.75 in)

Insertion Ring

Inner diameter	14.4 cm (5.68 in)
Insertion depth	5 cm (1.97 in) 10 cm (3.94 in)

Borehole Infiltrometer Head

Total height	28.78 cm (11.33 in)
Inner diameter	8.26 cm (3.25 in)

COMPLIANCE

2004/108/EC and 2011/65/EU

3.2 COMPONENTS

SATURO consists of four main components: the control unit, insertion ring, infiltrometer head, and water supply tank ([Figure 13](#)).

Optional SATURO Borehole main components include: the borehole infiltrometer head, extension rod, slide hammer, and auger handle ([Table 2](#)).

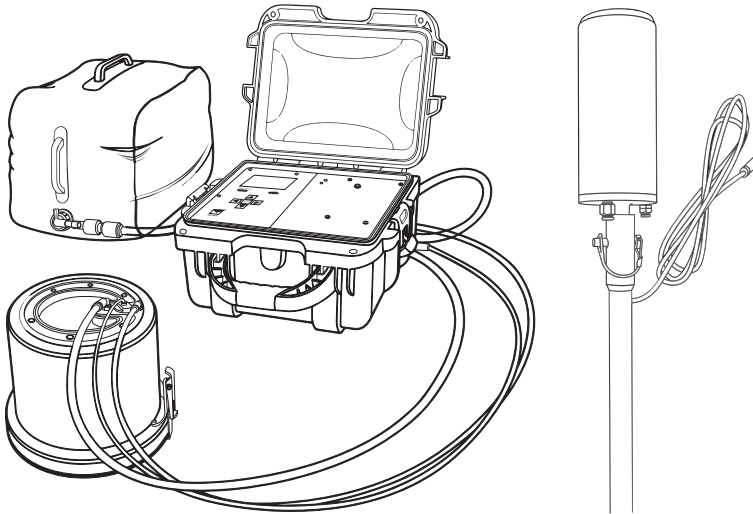

Figure 13 SATURO and optional Borehole components

3.2.1 CONTROL UNIT

The SATURO control unit has seven buttons to navigate through screens and configure settings (Figure 14):

- When the device is off, press the **POWER/MENU** button to turn on the device.
Hold the **POWER/MENU** button down for more than 4 s to power off the device. This button also navigates between different screen tabs.
- Pressing the **BACK** button returns the device to the parent screen. Pressing **BACK** on a selection screen cancels any changes that have been made on that screen.
Holding **BACK** down for more than 7 s resets the device (hard reset).
- The **UP**, **DOWN**, **LEFT**, and **RIGHT** buttons on the directional pad allow navigation through lists and scroll wheels. Pressing **LEFT** or **RIGHT** will highlight successive items in a list and holding down the button will speed up scrolling.
- The **Enter** button selects the highlighted item to go to a submenu or save the highlighted setting to memory.

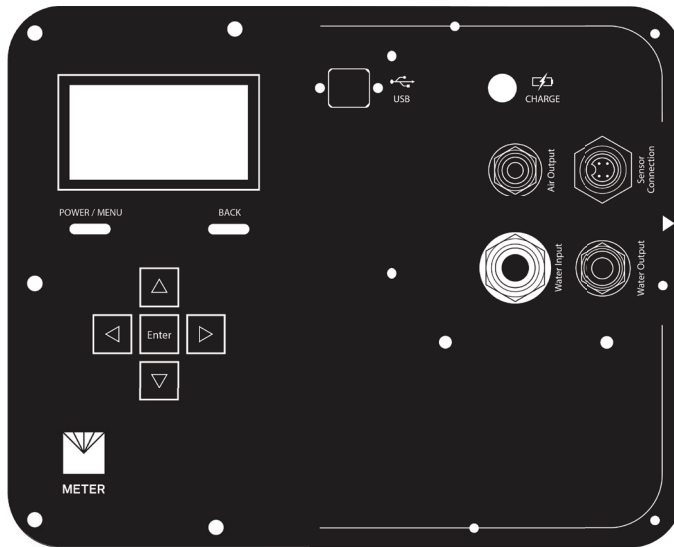

Figure 14 Control unit faceplate

The control unit is charged through a 18-V, 2.22-A, 40-W AC/DC charger. The unit takes approximately 6 h to fully charge.

The control unit USB port takes a Type B to Type A USB to download data and to perform firmware updates.

There are four connections on the control unit (Figure 15):

- Top left connection is for the 9.5-mm (3/8-in) water input (water tank to control unit).
- Bottom left connection is for the 7.9-mm (5/16-in) water output (control unit to infiltrometer head).
- Bottom right connection is for the sensor connection to the infiltrometer head.
- Top right connection is a 6.4-mm (1/4-in) air output (control unit to infiltrometer head).

SYSTEM

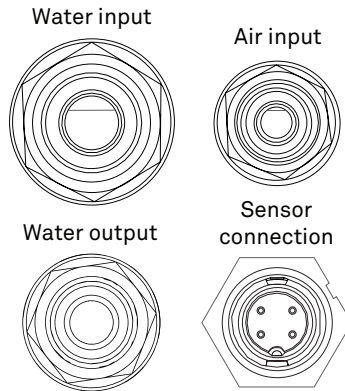

Figure 15 Control unit connections

The SATURO display (Figure 16) features three main tabs designed for ease of use: Reading, Configuration, and Data.

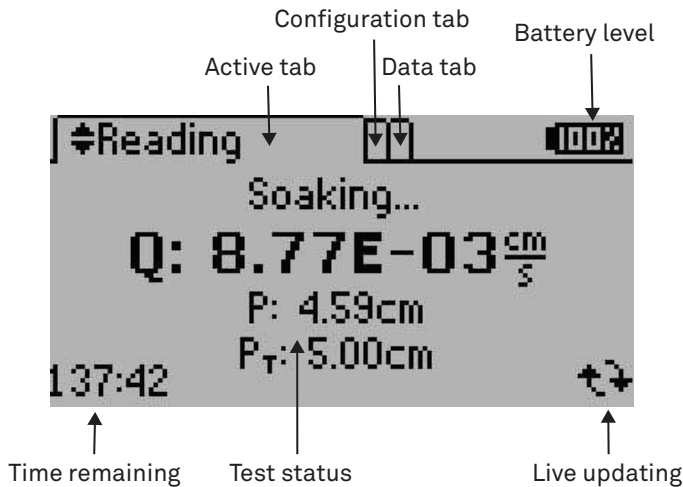

Figure 16 SATURO display elements

READING TAB

The Reading tab is used to view screens related to the current tests, including charts from the most recent flux, pressure, and water level readings. Use **UP** and **DOWN** to scroll through the available reading screens.

- **Status Screen.** The Status screen shows the test status, such as **Soaking** (Figure 17). When the test is completed, it changes to the Results screen.

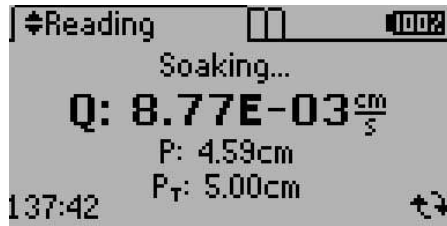

Figure 17 Status screen during test

- **Flux Screen.** The Flux screen displays the flow rate of water flow through the infiltrometer on a graph updated every minute (Figure 18). The current measurement is indicated by a flashing dot.

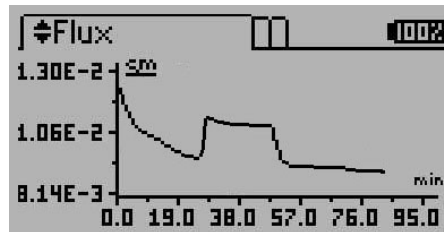

Figure 18 Flux screen

- **Pressure Screen.** The Pressure screen displays the hydrostatic pressure (combined air and water pressure) on a graph updated every minute (Figure 19). The current measurement is indicated by a flashing dot.

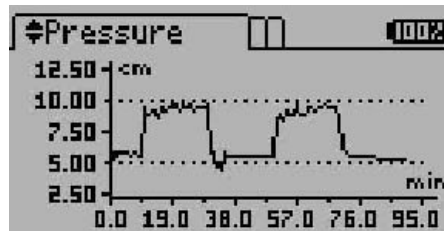

Figure 19 Pressure screen

- **Water Level Screen.** After a test is started, the water level above the soil ramps up to 5 cm. The Water Level screen displays the current water level on a graph that is updated every minute (Figure 20). The current point is indicated by a flashing dot.

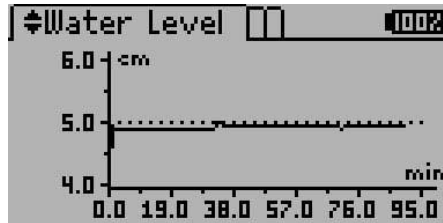

Figure 20 Water Level screen

- **Results Screen.** After a test is complete, the Results screen replaces the Status screen. It shows the resulting K_f of the test (Figure 21). The error (err) value also appears on the Results screen. The err is the standard error of the K_f reading and represents the amount of noise in the measurement. Press **UP** and **DOWN** to change Reading screens or press the **POWER/MENU** button to navigate to the Configuration tab.

SATURO will display the results from the last test if no test is running.

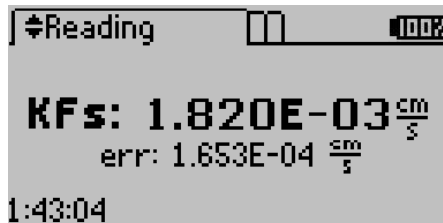

Figure 21 Results screen

CONFIGURATION TAB

The Configuration tab is used to view and set global preferences (Figure 22). Press the **POWER/MENU** button to navigate to the Configuration tab. Use the **UP** and **DOWN** buttons to scroll through options.

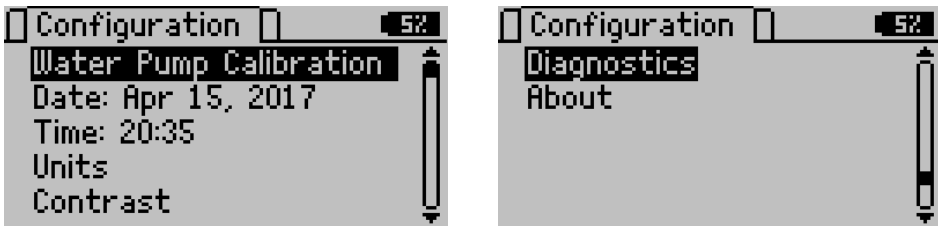

Figure 22 Configuration tab

- **Water Pump Calibration.** Water pump calibration is addressed in [Section 4.1](#).

- **Date.** Edit this screen to change the date saved in the control unit (Figure 23).

Select the **Date** option in the Configuration tab. Use **UP** and **DOWN** to change the current value and hold the buttons down to scroll quickly. Press **RIGHT** to move to the next value or press **LEFT** to return to the previous value. Select **Done** to save changes or press **BACK** to cancel without saving changes.



Figure 23 Editing Date option

- **Time.** Edit this screen to change the time saved in the control unit (Figure 24).

Select the **Time** option in the Configuration tab. Use **UP** and **DOWN** to change the current value and hold the buttons down to scroll quickly. Press **RIGHT** to move to the next value or press **LEFT** to return to the previous value. Select **Done** to save changes or press **BACK** to cancel without saving changes.



Figure 24 Editing Time option

- **Units.** Edit the preferred units on all device screens and the units that appear in downloaded data (Figure 25).

Select the **Units** option in the Configuration tab. Press **Enter** to cycle through the available options on the highlighted measurement. Press **BACK** to return to the previous menu.

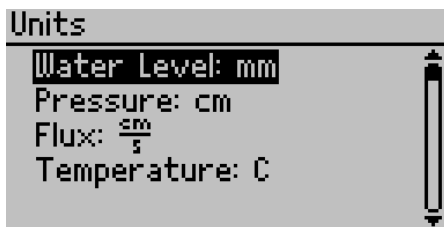

Figure 25 Editing Units options

- **Contrast.** Change the screen lighting contrast settings (Figure 26).

Select the **Contrast** option on the Configuration tab. Use the directional buttons to change the contrast to any value from 00–25. Use **RIGHT** and **LEFT** to highlight **Done** and press **Enter** to save the new contrast setting. Press **BACK** to exit without saving changes.



Figure 26 Editing Contrast option

- **Diagnostics.** Shows all the current readings from the instrument: water level (the current water level above the soil); air pressure (pressure in the head space of the infiltrometer assembly); battery (current battery voltage); charging status (observed voltage from charging power supply); temperature (internal temperature of the control unit); and cap sensor (measured voltage of the cap sensor, which is proportional to the humidity within the control unit) (Figure 27).

The Diagnostics option also tracks the usage information for the water pump, cartridge, and air pump to track when parts need to be replaced. This screen provides valuable information for maintenance and troubleshooting (Section 4.2). No changes can be made in this screen.

Press **BACK** to return to the previous menu.

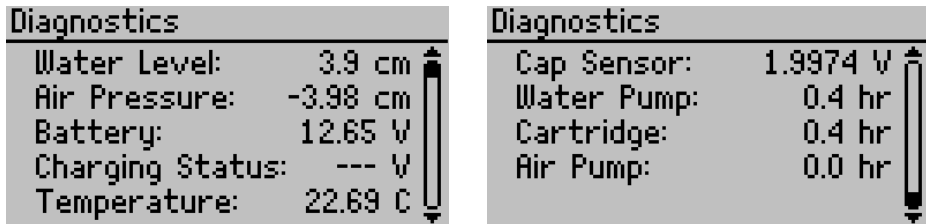

Figure 27 Viewing the Diagnostics option

- **About.** Displays the instrument's serial number, firmware version, hardware version, copyright date, and manufacturer's name (Figure 28).

Select the **About** option on the Configuration tab and press **Enter**. No changes can be made in this screen. Press **BACK** to return to the previous menu.



Figure 28 Viewing the About option

DATA TAB

The Data tab provides access to past test data. Press the **POWER/MENU** button to navigate to this tab.

- **View.** Lists prior tests stored on the device, most recent first.

To view a test, scroll to desired test and press **Enter**. The Results (including final K_{fs} value, water level chart, pressure chart, and flux chart), Settings, and Raw Data screens from that test can all be viewed. Scroll through the available information by using the **UP** and **DOWN** buttons. Press **BACK** to return to the previous screen.

- **Delete.** Deletes all test data in device memory. There is no way to delete individual tests or readings from the infiltrometer. It erases all test data.

WARNING: Deleting test data permanently removes it from the control unit, and it cannot be recovered. It is recommended that you download any test data prior to deleting the test data from the instrument.

3.2.2 INSERTION RING

The insertion ring is available in two depths: 5 cm and 10 cm. The 5-cm insertion ring (Figure 29) is primarily designed for sites with good soil structure. It reduces the impact from inserting the ring, so it is recommended for most sites. The 10-cm insertion ring was designed for sites with a disturbed or loose soil surface as well as sites with high fluxes due to macropores. The deeper insertion ring can also be helpful in forest or organic soils with a deep duff or organic layer at the surface.

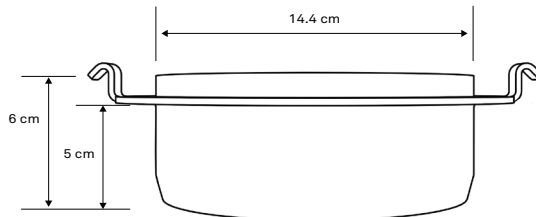

Figure 29 5-cm insertion ring

3.2.3 INFILTROMETER HEAD

The infiltrometer head houses the water level (depth) sensor (to control the water level), water connection, and air connection with push-to-connect fittings (Figure 30).

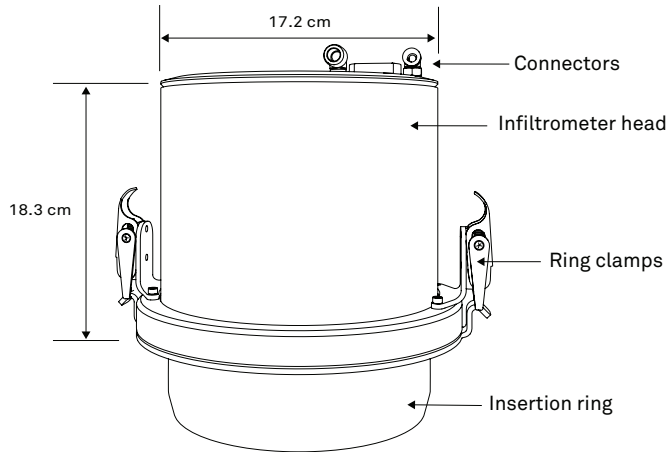

Figure 30 Infiltrator head

3.2.4 WATER SUPPLY TANK

The water supply tank holds up to 5 gal (18.9 liters) and is sufficient for lower permeability sites (Figure 31). Some sites with higher infiltration rates will use more than 5 gal (18.9 liters) of water in the time necessary to complete a measurement. The Y-connector may be used to connect two water tanks to SATURO, doubling the water supply available for a measurement.

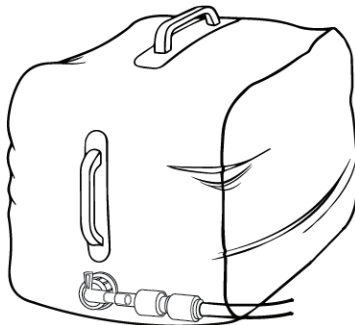

Figure 31 Water tank

3.2.5 BOREHOLE INFILTRMETER HEAD

The borehole infiltrometer head houses the water level depth sensor (to control the water level), water connection, and air connection with push-to-connect fitting. The ring has a beveled ring for easier insertion into the soil.

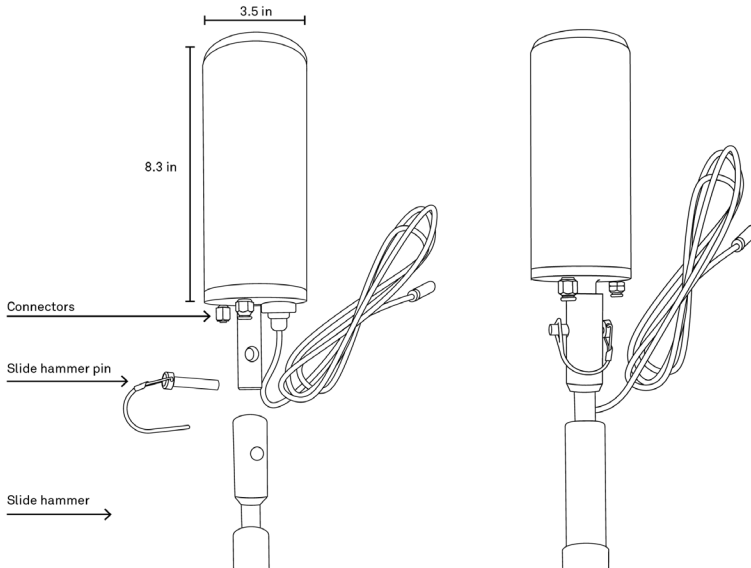

Figure 32 Borehole infiltrometer head

3.3 THEORY

Field saturated hydraulic conductivity, K_{fs} (cm/s) is a fundamental soil hydraulic property that describes the ease with which a fluid (usually water) can move through pore spaces or fractures under field saturated conditions. One of the oldest and simplest methods for in situ determination of K_{fs} has involved the measurement of ponded infiltration (D) from within a single ring (with a radius b) pushed a small distance into the soil (d) (Figure 33). The original analysis used the measured steady flow rate, Q , (cm³/s), and assumed one-dimensional, vertical flow to obtain K_{fs} from Bouwer (1986) and Daniel (1989).

SYSTEM

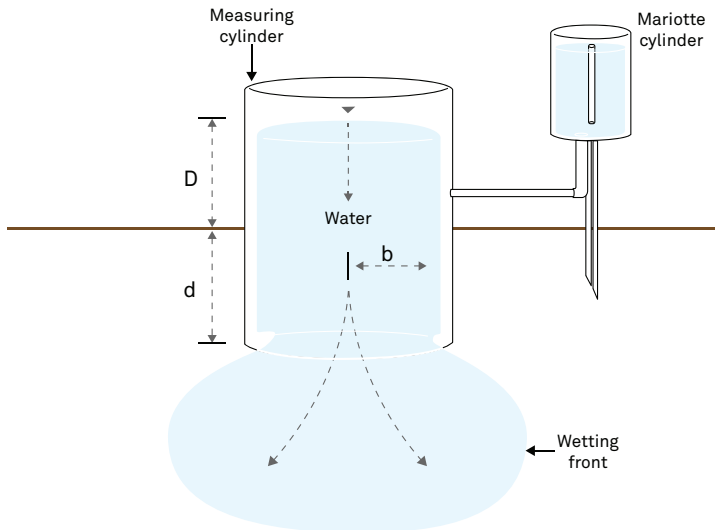

Figure 33 Cross section of a single-ring infiltrometer

This approach overestimated K_{fs} due to lateral divergence of flow resulting from the capillarity of the unsaturated soil and from the ponding in the ring (Bouwer 1986). Attempts to eliminate flow divergence involved the addition of an outer ring to buffer the flow in the inner ring (Figure 34). However, the double-ring infiltrometer technique was ineffective at preventing lateral flow from the inner ring (Swartzendruber and Olson 1961a, 1961b).

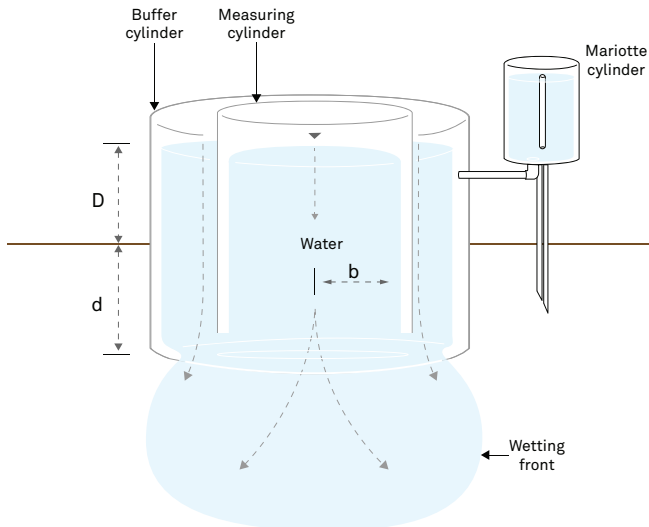

Figure 34 Cross section of a double-ring infiltrometer

More recent research provides new methods for correcting for lateral flow. Reynolds and Elrick (1990) presented a new analysis method of steady ponded infiltration into a single ring, which accounts for soil capillarity, depth of ponding, ring radius (b), and depth of ring insertion (d) and provides a means for calculating K_{fs} , matric flux (ϕ_m), and macroscopic capillary length (∞). This analysis is known as the two-ponding head approach (Reynolds and Elrick 1990).

The two-ponding head approach is the technique used by SATURO, though with some modifications and simplifications. The simplest equation for this calculation is from Nimmo et al. (2009). They compute K_{fs} as shown in Equation 1.

$$K_{fs} = \frac{i}{F} \tag{Equation 1}$$

where i (cm/s) is the steady (final) infiltration rate (volume divided by area) and F is a function that corrects for sorptivity and geometrical effects.

Nimmo et al. (2009) gives F as shown in Equation 2

$$F = 1 + \frac{\lambda + D}{C_1 d + C_2 b} = 1 + \frac{\lambda + D}{\Delta} \tag{Equation 2}$$

where

- D is the ponding depth (cm)
- d is the insertion depth of the infiltrometer (cm)
- b is the radius of the infiltrometer (cm)
- Δ is the constant for a given infiltrometer geometry; $C_1 d + C_2 b$ (cm)
- C_1 is 0.993
- C_2 is 0.578
- λ is the reciprocal of the Gardner, which is a characteristic of the soil and its initial water content (cm)

In Equation 2, Δ is simply Equation 36 of Reynolds and Elrick (1990) multiplied by $b\pi$, which allows Figure 2 and Equation 2 to be reconciled with Equation 37 of Reynolds and Elrick (1990).

For two ponding depths, use Equation 3:

$$K_{fs} = \frac{i_1}{\lambda + D_1} = \frac{i_2}{\lambda + D_2} \tag{Equation 3}$$

Rearranging one of the right terms to solve for λ in terms of K_{fs} , substituting this for λ in the other right term, and simplifying yields

$$K_{fs} = \frac{(i_1 - i_2)}{D_1 - D_2}$$

Equation 4

where

D_1 is the actual high pressure head

D_2 is the actual low pressure head

Δ is $0.993d + 0.578b$ (cm)

i_1 is infiltration rate at the high pressure head

i_2 is infiltration rate at the low pressure head

For Δ , d is the infiltrometer insertion depth and b is the infiltrometer radius. For the SATURO 5-cm insertion ring, $d = 5$ cm and $b = 7.6$ cm, so $\Delta = 9.4$ cm. For the 10-cm insertion ring, $d = 10$ cm and $b = 7.6$ cm, so $\Delta = 14.3$ cm. For the SATURO Borehole infiltrometer head $d = 5$ cm and $b = 4.15$ cm so $\Delta = 7.36$ cm.

The hydraulic conductivity is then multiplied by the difference in quasi-steady state infiltration rate for the last pressure cycle and divided by the difference in the measured pressure head from the last pressure cycle.

Equation 4 is equivalent to Equation 41 from Reynolds and Elrick (1990) and removes the dependence on soil characteristics and initial water content described by λ .

4. SERVICE

This section describes the calibration and maintenance of the SATURO infiltrometer. Troubleshooting solutions and customer service information are also provided.

4.1 CALIBRATION

The water pump comes factory calibrated and is accurate within $\pm 5\%$ of the reading at the time of shipment. However, the water pump and tubing can wear, causing a change in the volume of water flowing through the pump. Calibrate the pump every 6–12 months to ensure accurate measurements.

Operators can use two methods, based on either mass or volume, to calibrate the pump. The mass method is the most accurate, and the volume method is more convenient. Either method is acceptable for calibration.

Prior to calibration, obtain either a scale accurate to 0.01 g or a 25-mL graduated cylinder, for the mass or volume method respectively.

Press **POWER/MENU**, select **Configuration**, and select **Water Pump Calibration** (Figure 35). Press **Enter** on **Type** to toggle between **Mass** or **Volume**, and select **Start**.

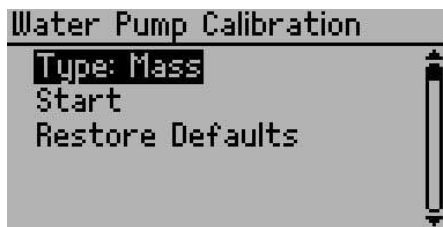

Figure 35 Water Pump Calibration screen

A message will prompt to connect to a water source and to attach the outgoing water tube (Figure 36). Connect a source of water to the water input port and press **Enter**.

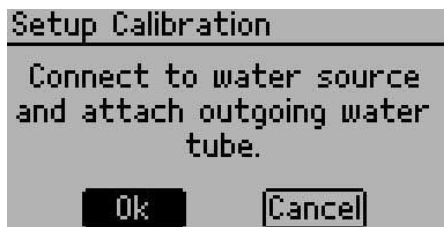

Figure 36 Setup Calibration screen

Both methods require that the water line is purged of air before running the calibration. Select **Purge**. Repeat the process to run water through the tube until water runs clear with no bubbles (Figure 37).

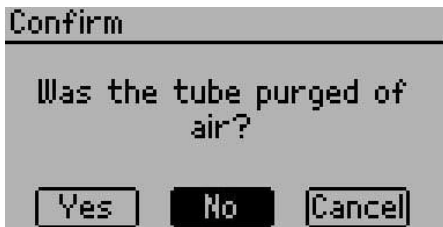

Figure 37 Confirmation screen

If using the mass method, tare the scale with the water tank. If using the volume method, ensure the graduated cylinder is empty. Select **Confirm** (Figure 38).

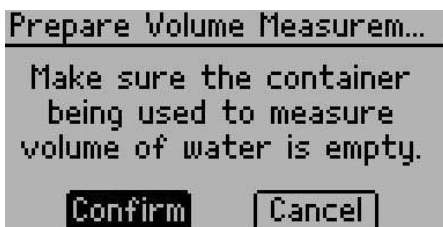

Figure 38 Prepare Volume Measurement screen

Run the calibration water flow. Compare the reading on the scale or the measurement on the cylinder to the infiltrometer default value on the Adjust Measured Value screen (Figure 39). Enter the new value from the scale or cylinder reading, and select **Done**. This value becomes the new default water flow value (Figure 40). SATURO uses this flow value to measure the flow of water into the infiltrometer head.

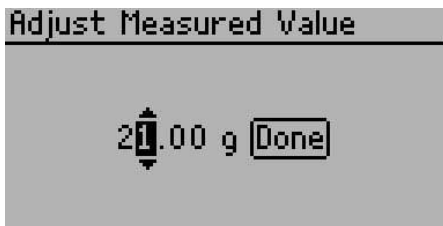

Figure 39 Adjust Measured Value screen

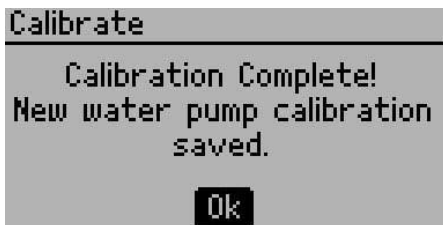

Figure 40 Calibration Complete screen

To remove the updated calibration values, highlight [Restore Defaults](#) on the Water Pump Calibration screen and press **Enter**.

Operators may run the calibration sequence as frequently as necessary to verify accurate readings. Once the calibration is complete, the new value stores in SATURO firmware until the next new calibration setting. Default pump amounts during calibration range from 20-30 mL. If pump values are lower than 20 mL, please contact [Customer Support](#).

4.2 MAINTENANCE

Replacement parts can be ordered from METER. Contact [Customer Support](#) for more information. The instrument can be sent in to update tubing, replace battery, inspect system, and clean instrument. SATURO may also be returned to METER for maintenance and any old or damaged parts will be replaced as a part of the maintenance program.

NOTE: Complimentary maintenance lasts for 1 year; [Customer Support](#) can provide parts and labor cost estimates after this timeframe ([Section 4.5](#)).

Properly clean the equipment after each use to ensure the longevity of SATURO.

- Remove any soil on the insertion ring to reduce the amount of resistance when installing the insertion ring.
- Remove soil particles and other materials on the infiltrometer head.
If soil particles or grass are left on the seal they could dry to the gasket causing it not to seal well during future use.
- Wipe down the three tubes with a wet rag.
- Inspect the insertion ring after each use for dents and dings incidental to normal use from hitting rocks and hard roots.
File away any dents or dings to the bottom edge of the ring so the inner part of the ring is smooth. Dings and dents protruding towards the inner portion of the ring can create channels and will allow for preferential flow.
- Purge water from water pump or run dry air through the tubing to dry out the control unit.
The SATURO will automatically purge water from the control unit after a test is completed (firmware versions 1.07 & higher.)
- Charge the control unit after each use.

Inspect bottom gasket at the end of every field season. If cracks or tears are present, replace the gasket with one of the spare gaskets provided.

The water pump on the SATURO is a peristaltic pump with a replaceable cartridge that houses the tube and rollers. The tubing and rollers can wear out over time, typically around 5,000 hours of run time. The pump run time is tracked in the diagnostics screen of SATURO.

If there is a significant change in pump calibration or the pump becomes inconsistent, it may need to be replaced. Contact [Customer Support](#) to request instrument servicing.

SATURO is powered by 12-V, 7-Ah sealed lead acid battery. Over time, there will be a decrease in the maximum charge value of the battery. If the battery does not come up to full capacity after a full charge (typically 4–6 h), it will need to be replaced. Contact [Customer Support](#) for a new battery and servicing.

The guidelines in [Table 4](#) may also help identify any potential maintenance problems.

Table 4 Diagnostics screen metrics

Metric	Acceptable Ranges/Required Servicing
Water Level	Should range from 3.9 to 6.2 cm
Air Pressure	Variable; should remain <40 cm
Battery	~11.1 to 13.7 V
Charging Status	Variable; recommend beginning test with 100%
Temperature	Do not exceed operating temperature; 0–50 °C
Cap Sensor	NA
Water Pump	Service at 500 h
Cartridge	Service at 500 h
Air Pump	Service at 500 h

NOTE: It is important to service the water pump cartridge at 500 h. If the cartridge is not serviced, the tubing could wear, potentially filling the control unit with water.

4.3 TROUBLESHOOTING

[Table 5](#) lists common problems and their solutions. If these solutions do not solve the issue, contact [Customer Support](#).

Table 5 Troubleshooting SATURO

Problem	Possible Solutions
SATURO does not turn on	Fully charge the battery. If this does not fix the issue, contact Customer Support .
Missing or damaged seal on infiltrometer head	If gasket is missing or damaged contact Customer Support for a replacement.
Firmware is corrupted! See Manual .	Check for firmware updates within the SATURO Downloader by clicking Help > Check for Firmware Updates. Connect SATURO to the computer and follow the instructions in the updater. WARNING: Taking this action deletes all data from the unit. NOTE: METER can extract data from units.
Test name already exists	If a new test has the same name as a completed test that is already stored in memory, then this message will appear. Rename the test.

Table 4 Troubleshooting SATURO (continued)

Problem	Possible Solutions
<p>Control unit shows low battery</p>	<p>Charge the battery to ensure it is fully charged.</p> <p>NOTE: This error occurs when the battery voltage drops below the minimum voltage at which the water pump can operate (11.1 V) during a test and stops the test.</p>
<p>Data memory is full.</p>	<p>Download the data from the infiltrometer and erase the stored data on the infiltrometer before performing a new test.</p>
<p>Test failed to reach the target water level</p>	<p>NOTE: The control unit will initially display Water level warning! If the water level remains below the water level sensor (4.3 cm) for more than 10 min, SATURO will stop the test and the control unit will display Water level error!</p> <p>Check that the water supply is connected and water is able to easily flow from the water supply through the control unit into the infiltrometer head.</p> <p>Check for leaks around the seal of the infiltrometer head.</p> <p>If SATURO is on a slope, the slope may be too great, and the water level will not reach the sensor.</p> <p>If there are no apparent leaks, the location may have an infiltration rate that exceeds the capacity of SATURO. Try sampling a new location or adding a second water supply to proceed with the measurements.</p> <p>NOTE: Soils with extremely high infiltration rates could cause the water inside the chamber to remain below 4.3 cm, if the water pump cannot fill the chamber at a rate greater than the soil's infiltration rate.</p>
<p>Water is leaking between seal of infiltrometer head and insertion ring</p>	<p>Remove the infiltrometer head and check for debris (grass, leaves, loose soil, etc.) where the gasket seals with the insertion ring. Remove any debris and reconnect the infiltrometer head.</p> <p>Check the tightness of the clamps. The clamps should only apply enough pressure to slightly compress the gasket. If the clamps are too tight, they can deform the insertion ring, causing a poor seal. Adjust the clamp pressure with the screw on top of the clamps as necessary.</p>

Table 4 Troubleshooting SATURO (continued)

Problem	Possible Solutions
Selected pressure heads are not being reached	Check tubing connections to ensure tubes are pressed all the way into the push-to-connect fittings. The tubes should hit the back of the fittings.
Infiltrometer does not maintain pressure	<p>Check tubing connections to ensure tubes are pressed all the way into the push-to-connect fittings.</p> <p>Check the infiltrometer head seals for grass or debris. Verify the clamps are not bent or deformed. Adjust the clamp screw to the appropriate tightness to seal the ring as necessary.</p> <p>NOTE: Tightening the clamp adjustment too tight will deform the metal.</p>
No depth sensor!	<p>Check sensor connection to the control unit.</p> <p>Verify it is measuring correctly by checking the Water Level value on the Diagnostics screen.</p> <p>If these actions do not fix the issue, contact Customer Support.</p>
Pressure limit exceeded!	<p>Check tubing for possible kinks or blockages.</p> <p>NOTE: This error occurs when the air pressure in the chamber is over 60.0 cm of water</p>
Vacuum limit exceeded!	<p>Check tubing for possible kinks or blockages.</p> <p>NOTE: This error occurs when the air pressure in the chamber is over -50.0 cm of water</p>
Temperature too low!	<p>Move the system into a warmer environment. After the system has warmed, turn the power off and on again to clear the temperature too low message.</p> <p>NOTE: This error occurs when the air temperature is below the minimum operating temperature (0 °C) while a test is running. Water frozen in the system could cause damage. The error will stop the test.</p>
Control unit becomes unresponsive	<p>Charge the battery.</p> <p>Press and hold the BACK button for more than 7 s to restart.</p> <p>If these actions do not fix the issue, contact Customer Support.</p>
Date and time were reset!	<p>Ensure the battery is fully charged and update the date and time in the Settings menu.</p> <p>If this action does not fix the issue, contact Customer Support.</p>
Missing bootstrap loader! See Manual.	<p>This error means firmware updates will not be possible on this instrument unless the instrument is serviced by Customer Support.</p> <p>The instrument may be used without consequences, but contact Customer Support for servicing so the instrument firmware can stay up to date with the latest features and bug fixes.</p>

4.4 CUSTOMER SUPPORT

NORTH AMERICA

Customer service representatives are available for questions, problems, or feedback Monday through Friday, 7:00 am to 5:00 pm Pacific time.

Email: support.environment@metergroup.com
sales.environment@metergroup.com

Phone: +1.509.332.5600

Fax: +1.509.332.5158

Website: metergroup.com

EUROPE

Customer service representatives are available for questions, problems, or feedback Monday through Friday, 8:00 to 17:00 Central European time.

Email: support.europe@metergroup.com
sales.europe@metergroup.com

Phone: +49 89 12 66 52 0

Fax: +49 89 12 66 52 20

Website: metergroup.com

If contacting METER by email, please include the following information:

Name	Email address
Address	Instrument serial number
Phone	Description of the problem

NOTE: For products purchased through a distributor, please contact the distributor directly for assistance.

4.5 TERMS AND CONDITIONS

By using METER instruments and documentation, you agree to abide by the METER Group, Inc. Terms and Conditions. Please refer to metergroup.com/terms-conditions for details.

REFERENCES

- Bouwer, Herman. 1986. Intake rate: Cylinder Infiltrometer. In Klute A., editor, *Methods of Soil Analysis: Part 1—Physical and Mineralogical Methods*. 2nd ed. Madison (WI): ASA and SSSA. 825–844.
- Dane, Jacob H. and G. Clarke Topp, editors. 2002. *Methods of Soil Analysis: Part 4—Physical Methods*. Madison (WI): Soil Science Society of America Inc.
- Daniel, David E. 1989. In Situ Hydraulic Conductivity Tests for Compacted Clay. *Journal of Geotechnical and Geoenvironmental Engineering*. 115(9).
- Nimmo, John R., Kevin M. Schmidt, Kim S. Perkins, and Jonathan D. Stock. 2009. Rapid Measurement of Field-Saturated Hydraulic Conductivity for Areal Characterization. *Vadose Zone Journal*. 8(1): 142–149.
- Reynolds, W. Daniel and Daniel E. Elrick. 1990. Pondered infiltration from a single ring: I. Analysis of steady flow. *Soil Science Society of America Journal*. 54(5): 1233–1241.
- Swartzendruber, Dale and Tamlin C. Olson. 1961. Sand-Model Study of Buffer Effects in the Double-Ring Infiltrometer. *Soil Science Society of America Proceedings*. 25(1): 5–8.
- Swartzendruber, Dale and Tamlin C. Olson. 1961. Model Study of the Double-Ring Infiltrometer as Affected by Depth of Wetting and Particle Size. *Soil Science*. 92(4): 219–225.

INDEX

B

borehole 27
Borehole 1, 5, 6, 17, 30

C

calibration 31–33
components
 charger 16, 19
 control unit 18
 depth sensor 26
 infiltrometer head 26
 insertion ring 25
 USB port 19
 water supply tank 26–27
connections 19
customer support 37–38

E

email address 37

F

fax number 37
field saturated hydraulic conductivity 1, 27

I

infiltration rate 10
installation 2

K

Kfs 1, 16, 27–31

L

lateral flow 28–29

M

maintenance
 battery 34
 cleaning 33–34

infiltrometer head 33
insertion ring 33
water pump 33

P

phone number 37
ponding depths 29

Q

quasi-steady state 10, 30

R

references 38
running a test
 downloading 13–14, 14–15
 starting 11
 stopping 13

S

SATURO Downloader 14–15
screen
 about 24
 contrast 23–24
 date 23
 diagnostics 24
 flux 21
 pressure 21
 results 22
 status 20
 time 23
 units 23
 water level 22–23
 water pump calibration 22
service. *See* maintenance
settings
 hold time 10
 pressure 9
 pressure cycles 10

INDEX

soak time 9–10
sorption 29
specifications 16

T

tab

Configuration 22–25
Data 25
Reading 20–22
terms and conditions 37
theory 27–30
troubleshooting 34–36

METER Group Inc.

2365 NE Hopkins Court Pullman, WA 99163
T: +1.509.332.2756 F: +1.509.332.5158
E: info@metergroup.com W: metergroup.com

METER Group GmbH

Mettlacher Straße 8, 81379 München
T: +49 89 1266520 F: +49 89 12665220
E: info.europe@metergroup.com W: metergroup.com

