



METER.

TEMPOS



TABLE OF CONTENTS

1. Introduction.....	1
2. System.....	2
2.1 Specifications.....	2
2.2 TEMPOS Controller	4
2.2.1 Main Menu	6
2.2.2 Take a Reading Screen.....	6
2.2.3 Measurement Configuration Screen.....	7
2.2.4 Stored Readings Menu	9
2.2.5 Unattended Mode Screen.....	11
2.2.6 Device Configuration Screen	13
2.2.7 About Screen.....	13
2.3 Selecting a Sensor	14
2.3.1 KS-3.....	14
2.3.2 TR-3	15
2.3.3 SH-3.....	15
2.3.4 RK-3	15
3. Operation	17
3.1 Controller Configuration	17
3.2 Measurement Configuration	18
3.3 Sensor Installation	21
3.3.1 Rock or Cured Concrete (RK-3)	22
3.3.2 Wet Cement.....	22
3.3.3 Solid Material (TR-3)	23

3.4	Take a Reading	23
3.5	Saving and Viewing a Reading	25
3.6	Interfacing with TEMPOS Utility.....	26
3.7	Install TEMPOS Utility.....	26
3.7.1	Download Data	26
3.7.2	Update Firmware Version	28
4.	Theory	29
4.1	Dual-Needle Algorithm	30
4.2	Single-Needle Algorithm	31
4.3	Understanding the S_{yx} Value	32
5.	Service.....	33
5.1	Sensor Maintenance and Verification	33
5.1.1	Verification with the KS-3, TR-3, or RK-3	33
5.1.2	Verification with the SH-3	35
5.2	Controller Maintenance	35
5.3	Troubleshooting	36
5.4	Customer Support.....	37
5.5	Terms and Conditions	37
	References	38
	Index	40

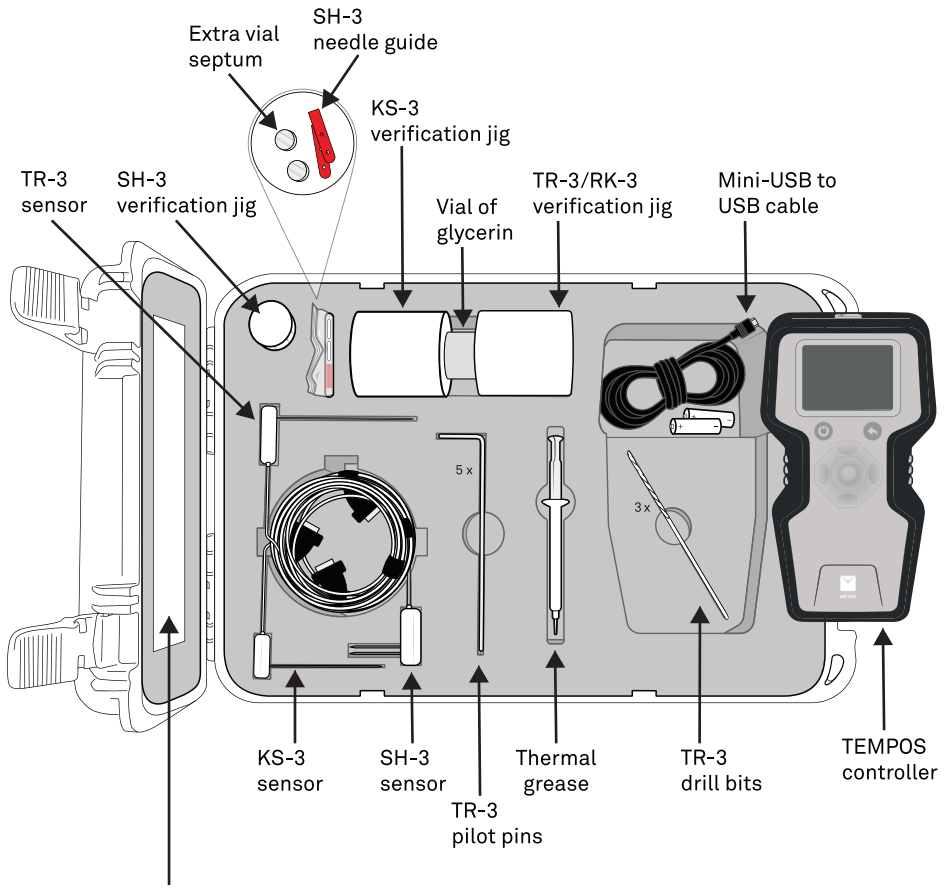

 METER

ATTENTION!
IMPORTANT DOCUMENTS ENCLOSED:
Safety Data Sheets (SDS)
Certificate of Analysis

1. INTRODUCTION

Thank you for purchasing the TEMPOS Thermal Properties Analyzer from METER Group.

This manual will help the user understand and use the TEMPOS controller to the best of its capability. Upon receipt, please verify that all components were shipped and appear in good condition.

- TEMPOS controller
- Carrying case
- Mini-USB data download cable
- 5 AA alkaline batteries (installed in TEMPOS controller)
- Glycerin verification standard
- Sensor positioning jigs
- Thermal grease
- Sensors (ordered with device)
- Pilot pins (if TR-3 sensor ordered)
- Drill bits (if TR-3 sensor ordered)
- Extra septum
- SH-3 needle guides (if SH-3 sensor ordered)
- SH-3 Delrin® verification block (if SH-3 sensor ordered)

The RK-3 Rock Sensor kit includes the following items and is available separately by contacting [Customer Support](#):

- 5/32-in (4-mm) drill bit
- RK-3 sensor
- Arctic alumina
- 1-m cable

NOTE: Custom cable lengths of 2, 3, 5, and 10 m are available upon request.

2. SYSTEM

This section describes the specifications and components of the TEMPOS system. The system comprises the handheld device ([Section 2.2](#)) and as many as four sensors ([Section 2.3](#)).

2.1 SPECIFICATIONS

OPERATING ENVIRONMENT

Controller	
Range	0–50 °C
Power	5 AA batteries
Battery life	More than 250 high-power measurements
Data storage	2,048 measurements in flash memory (both raw and processed data are stored for download)
Read Modes	Manual and unattended measurement modes
Sensors	
Range	–50 to 150 °C

PHYSICAL CHARACTERISTICS

Controller	
Length	18.5 cm (7.28 in)
Width	10 cm (3.94 in)
Height	3.5 cm (1.38 in)
Carrying case	
Length	37 cm (14.57 in)
Width	30 cm (11.81 in)
Height	10.5 cm (4.13 in)
Display size	
Width	5.5 cm (2.17 in)
Height	4.0 cm (1.57 in)
Sensor interface	
DB-15 connector	

SENSORS**KS-3 (6-cm [small] single needle)**

Range

Conductivity 0.02–2.00 W/(m • K)

Resistivity 50–5,000 °C • cm/W

Accuracy

Conductivity $\pm 10\%$ from 0.2–2.0 W/(m • K)

Size 1.3 mm diameter × 60 mm length

TR-3 (10-cm [large] single needle)

Range

Conductivity 0.1–4.0 W/(m • K)

Resistivity 25–1,000 °C • cm/W

Accuracy

Conductivity $\pm 10\%$ from 0.1–4.0 W/(m • K)

Size 2.4 mm diameter × 100 mm length

SH-3 (3-cm dual-needle)

Range

Conductivity 0.02–2.00 W/(m • K)

Resistivity 50–5,000 °C • cm/W

Diffusivity 0.1–1.0 mm²/sVolumetric specific
heat capacity 0.5–4.0 MJ/m³

Accuracy

Conductivity $\pm 10\%$ from 0.02–2.0 W/(m • K)Diffusivity $\pm 10\%$ at conductivity above 0.2 W/(m • K)
 ± 0.02 W/(m • K) from 0.10–0.20 W/(m • K)Volumetric specific
heat capacity $\pm 10\%$ at conductivities above 0.1 W/(m • K)

Size 1.3 mm diameter × 30 mm length, 6 mm spacing

RK-3 (6-cm [thick] single needle)

Range

Conductivity 0.1–6.0 W/(m • K)

Resistivity 17–1,000 °C • cm/W

Accuracy

Conductivity $\pm 10\%$ from 0.1–6.0 W/(m • K)

Size 3.9 mm diameter × 60 mm length

COMPLIANCE

Manufactured under ISO 9001:2015

EN 61326-1:2013

EN 55022/CISPR 22

2.2 TEMPOS CONTROLLER

The TEMPOS controller has a DB-15 pin receiver to connect to TEMPOS sensors. The other port on the reader is a mini-USB port for downloading data ([Section 3.6](#)).

Every menu screen ([Figure 1](#)) contains a header bar that displays (from left to right) the current reading mode, time, current sensor pairing, and battery status.

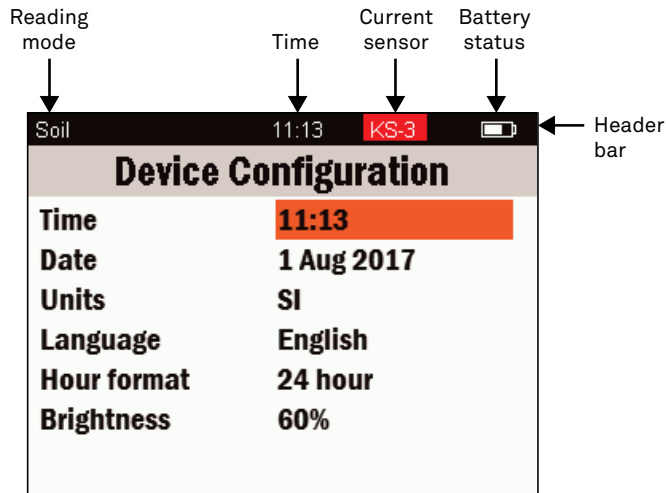

Figure 1 TEMPOS screen components

The **POWER** button ([Figure 2](#)) turns the TEMPOS controller on and off. To completely power down the unit, press the **POWER** button and hold for 5 s.

Pressing the **BACK** button ([Figure 2](#)) moves the cursor back to the previous screen. When it is pressed multiple times, the cursor moves back to the Main menu. Changes are automatically saved.

The central control of the TEMPOS controller is the D-pad ([Figure 2](#)). Selecting configurations or options in the TEMPOS controller will require the use of these buttons.

- The **CENTER** button ([Figure 2](#)) serves as the Select or Enter function.

TEMPOS

- The **UP**, **DOWN**, **RIGHT**, and **LEFT** buttons (Figure 2) are active when an icon or text on the display screen is highlighted in red. These arrows allow the user to scroll within a field or to select a field before pressing the **CENTER** button.

The device automatically goes to sleep when not used for more than 5 min. While in unattended mode, the screen will turn off after 5 min, but scheduled readings will continue.

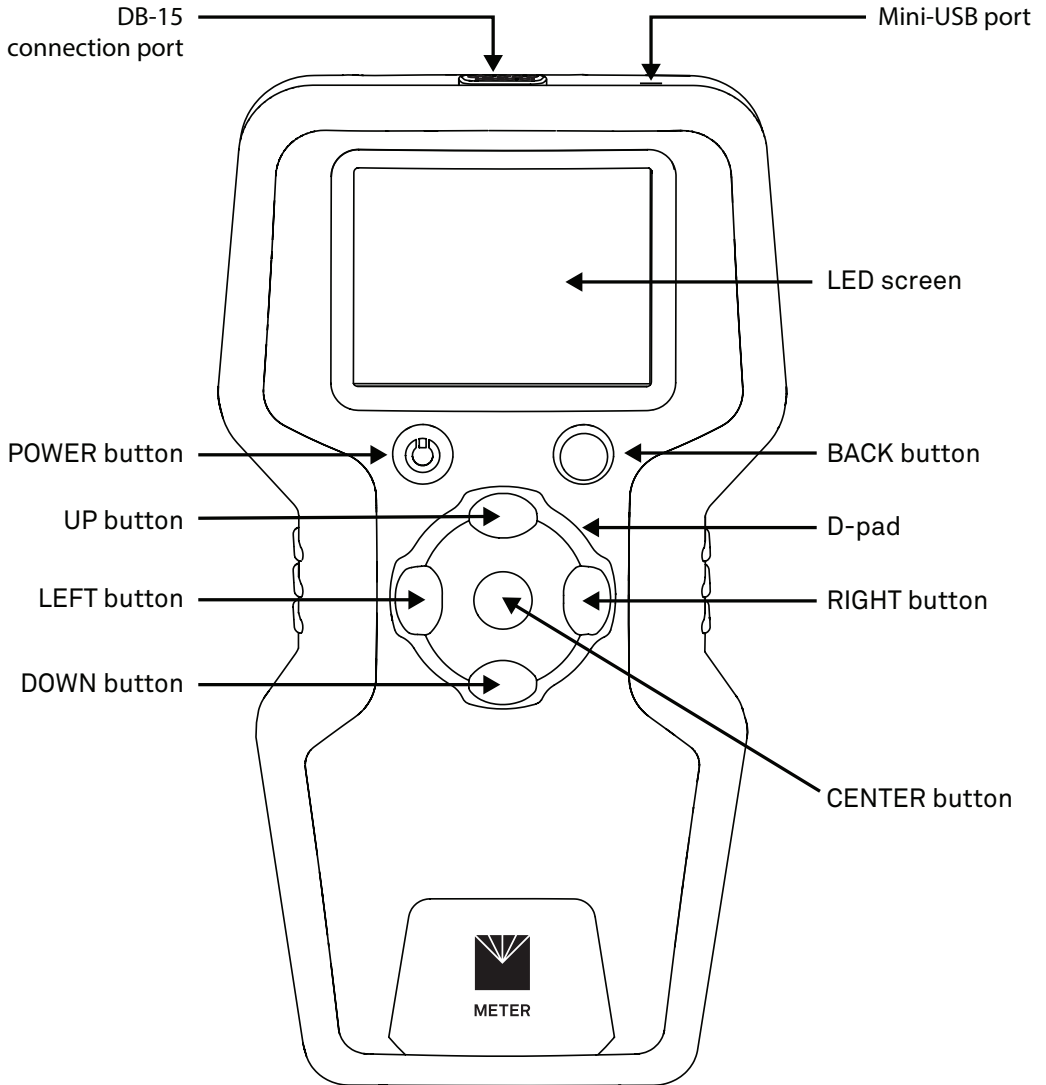

Figure 2 TEMPOS controller

2.2.1 MAIN MENU

The Main menu is the starting point for all of the firmware applications within the device.

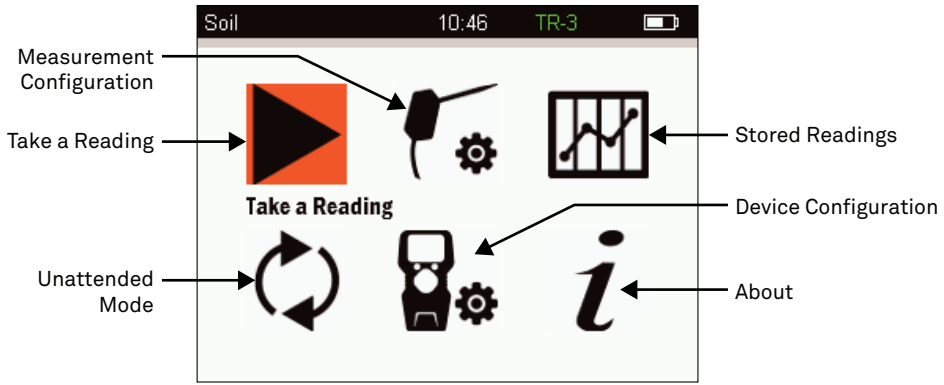

Figure 3 Main menu

There are six icons in the Main menu that represent the six main functions of the TEMPOS.

- Taking a Reading ([Section 2.2.2](#))
- Measurement Configuration ([Section 2.2.3](#))
- Stored Readings ([Section 2.2.4](#))
- Unattended Mode ([Section 2.2.5](#))
- Device Configuration ([Section 2.2.6](#))
- About ([Section 2.2.7](#))

2.2.2 TAKE A READING SCREEN

The Take a Reading screen is where a user will start a single measurement after configuring measurement options.

To reach the Take a Reading screen, select the icon labeled Take a Reading in the Main menu ([Figure 4](#)). The last completed reading will be displayed on the Take a Reading screen.

- If the sensor name is highlighted in **RED**, the sensor is not compatible with the mode.
- If a sensor name (KS-3, TR-3, SH-3, or RK-3) does not appear in the header bar, the reader has not detected any sensor.
- If the sensor name is in **GREEN**, it is compatible with the selected reading mode ([Section 3.2](#)).

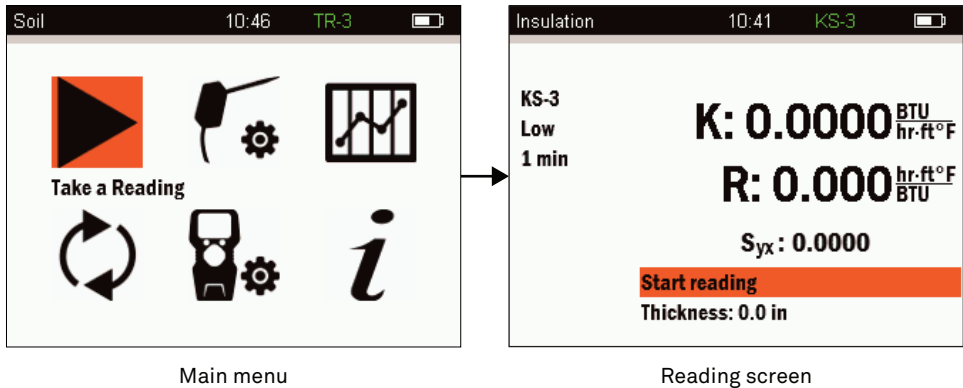

Figure 4 Navigating to the Take a Reading screen

2.2.3 MEASUREMENT CONFIGURATION SCREEN

The Measurement Configuration screen is where a user will select the correct option for desired readings.

To reach the Measurement Configuration screen, select the Measurement Configuration icon on the Main menu.

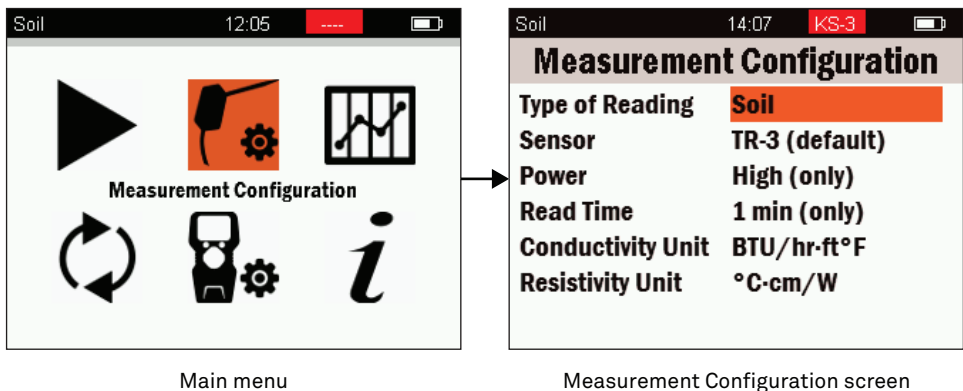

Figure 5 Navigate to the Measurement Configuration screen

CHANGING DEFAULT VALUES

Default values will show in the Measurement Configuration screen when a Type of Reading has been selected (Figure 5). Each reading mode has the following settings options for optimal configuration based on the material:

- Sensor type
- Power level
- Read time
- Conductivity units
- Resistivity units

Setting values that include the label **(default)** can be changed to a different value. Depending on the type of reading selected, the default settings may not be changed and will be labeled **(only)** after the settings value. This is the only place in the controller that these configuration options can be changed. The conductivity and resistivity units may be modified in all situations. Refer to Figure 5 for examples of the use of the **(default)** and **(only)** labels on the Sensor, Power, and Read Time measurement categories.

NOTE: Changing between the SI and Imperial units also changes the units on all previous readings saved in the memory.

CHOOSING THE BEST POWER MODE

The TEMPOS controller will automatically choose the best heating time for the material selected in the Measurement Configuration screen (Figure 5).

Configure the TEMPOS controller to measure each of the four sensor types in either high-power mode or low-power mode by selecting the reading type Conductivity/Resistivity (Diffusivity/Heat Capacity for the SH-3 sensor) in the Measurement Configuration screen (Figure 14). In high-power mode, the TEMPOS controller applies a relatively large heating current to the sensor during a measurement that results in greater sensor heating. In low-power mode, the TEMPOS controller applies a small current to the sensor resulting in less heating of the sensor. The KS-3 needle defaults to low-power mode, while the TR-3, SH-3, and RK-3 needles default to high-power mode.

METER recommends that only expert operators change the power mode from the default settings for special measurements. In all but a few cases, changing the power mode from the default settings results in reduced accuracy. Contact [Customer Support](#) to discuss specific measurements before changing from the default power-mode setting.

CAUTION: Do not attempt to make measurements in liquids with the KS-3 or TR-3 in high-power mode. The additional heating from the higher heat input causes free convection and compromises the measurement.

CAUTION: Do not attempt to make measurements in liquids with the SH-3 (dual-needle) or RK-3 sensors.

One motivation behind allowing Power Mode Configuration (Section 3.2 and Section 3.4) is to allow the TR-3 and SH-3 sensors to make better measurements in frozen materials where the decreased heat input in low-power mode is less likely to cause phase change (melting) of the frozen sample. One situation where it is not recommended that a nondefault power-mode setting is the measurement of the thermal conductivity of snow. In this case, the TR-3 needle is recommended to reduce issues with contact resistance, and it is recommended that the sensor be configured to low-power mode to reduce issues with melting.

2.2.4 STORED READINGS MENU

The Stored Readings menu allows the user to view all stored records or erase stored records. The screen also indicates the number of records stored and the percentage of memory still available to store records.

To reach the Stored Readings screen, select the Stored Readings icon on the Main menu. Use the D-pad to select one of the two options (Figure 6):

- View
- Erase

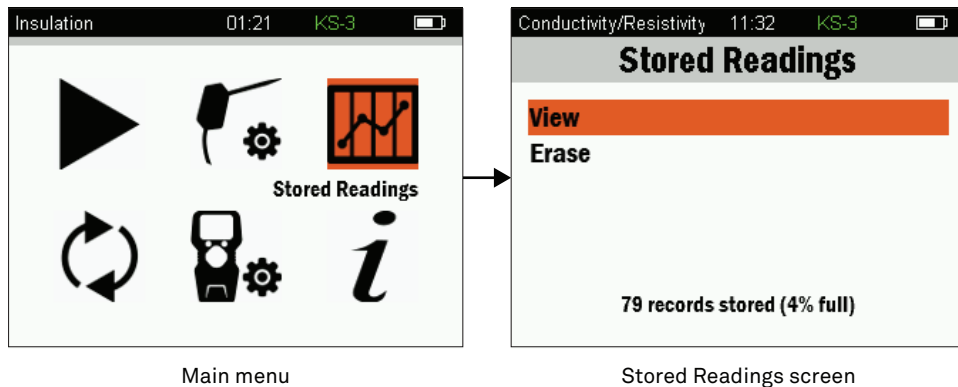

Figure 6 Stored Readings menu

VIEW

From the Stored Readings screen (Figure 6), select the View option. This allows a user to view all the data currently stored in the TEMPOS controller (Figure 7). Measurements are stored in the order they are taken.

Index	Tags	Annotation	Date
1	V	Verification	12 Jul 2017
2	V	Verification	12 Jul 2017
3	V	Verification	12 Jul 2017
4	-	Saved	12 Jul 2017
5	-	Saved	12 Jul 2017
6	U	sh_gly2.1	12 Jul 2017
7	U	sh_gly2.2	12 Jul 2017
8	U	sh_gly2.3	12 Jul 2017
9	U	sh_gly2.4	12 Jul 2017
10	U	sh_gly2.5	13 Jul 2017
11	U	sh_gly2.6	13 Jul 2017
12	U	sh_gly2.7	13 Jul 2017

Figure 7 Data View list

There are four columns in the Data View list:

1. Index—the sequential number assigned to the reading.
2. Tags—the designate measurements of particular interest:
 X = The measurement is suspect (error term or temperature drift is high).
 V = A verification measurement.
 U = A measurement taken in unattended mode.
3. Annotation—the annotation, if one has been made.
4. Date—the date the measurement was taken as per the settings in Device Configuration.

ERASE

From the Stored Readings screen ([Figure 6](#)) select the Erase option. This will erase all the data stored on the TEMPOS controller and the data is not recoverable.

IN-DEPTH DATA VIEWING

Toggle up or down through the initial view. The highlighter bar indicates the selected saved reading.

Press the **CENTER** of the D-pad to access additional information about the highlighted reading.

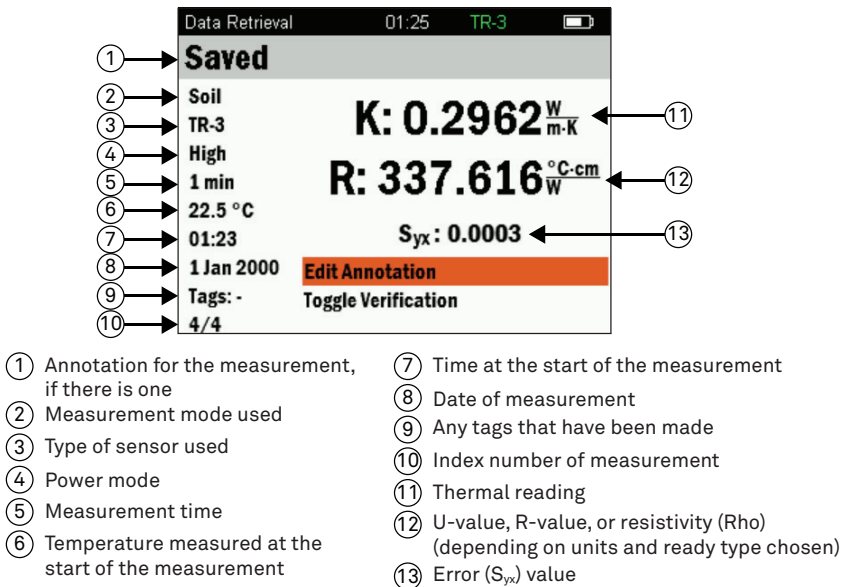

Figure 8 Toggle verification screen

EDIT ANNOTATION OR TOGGLE VERIFICATION

To Edit Annotation or Toggle Verification (Figure 8) select the desired feature with the CENTER button.

- **Edit Annotation** allows changes to be made to the original annotation.
- **Toggle Verification** allows the user to add the V (verification) tag to any measurement. This feature is available for users that need to record the measurements they use to verify the TEMPOS is reading correctly.

When finished, press the **BACK** button to return to the previous menu.

2.2.5 UNATTENDED MODE SCREEN

Unattended Mode (Figure 9) allows the user to automatically make multiple readings at specified intervals. To reach the Unattended Mode screen, select the Unattended Mode icon on the Main menu.

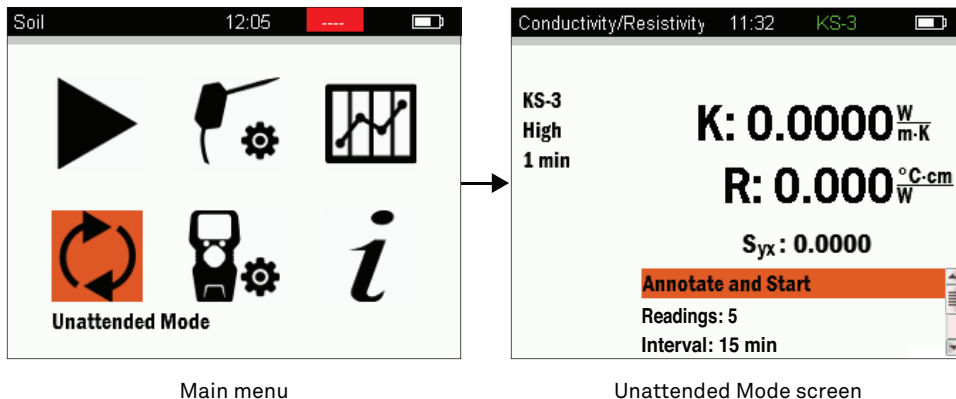

Figure 9 Unattended Mode screen

1. Use the Readings option to select the number of readings to take in any given measurement session.
 - a. Use the D-pad to navigate to the Readings option and push the **CENTER** button.
 - b. Use the **UP** and **DOWN** arrows to toggle to the number of readings desired.
The number increases sequentially from 1–120. Above 120 readings, select max, which programs the reader to run continuously until stopped or batteries fail.
 - c. Toggle to the **RIGHT** to select Done.
2. Use the Thickness option, available only when measuring insulation, to select the thickness of the medium.
This will be used in determining a resistance (R-value).
3. Use the Interval option to program the frequency of readings.
For the first 15–60 min, choose intervals in increments of 5 min. After 60 min, intervals increase by 1-h increments.
4. Use the Annotate and Start option to name the readings with a comment. Once an annotation is made, readings will begin.
Set the number of readings and interval before choosing this menu option.

NOTE: Readings will be saved with the annotation given to them, followed by the measurement number in the sequence being taken. For instance, if setting the annotation to Reading, the reader will save readings as Reading1, Reading2, Reading3, etc.

2.2.6 DEVICE CONFIGURATION SCREEN

The Device Configuration screen is where a user can set the TEMPOS controller settings. These settings are universal and will influence all readings and data saved on the TEMPOS controller.

To reach the Device Configuration screen, select the Device Configuration icon on the Main menu.

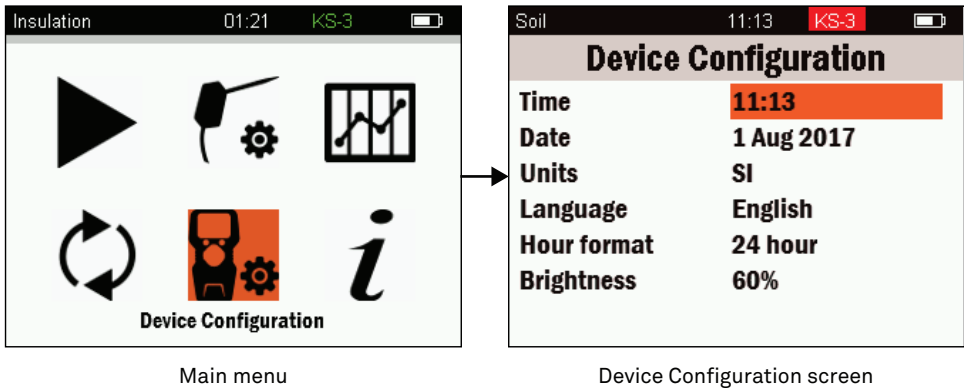

Figure 10 Device Configuration screen

2.2.7 ABOUT SCREEN

The About screen (Figure 11) provides a view of the device serial number and the version of firmware the device is running. No changes can be made in this screen.

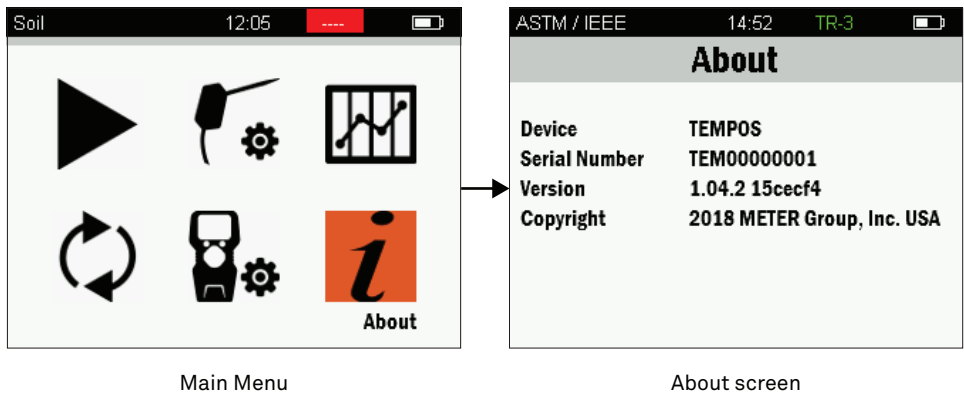

Figure 11 About screen

2.3 SELECTING A SENSOR

The TEMPOS controller can read four different sensors. The sensors (KS-3, TR-3, SH-3, and RK-3) are designed for measurements in specific sample types and in specific use cases.

Table 1 shows compatibility of certain probes with the desired medium to measure.

Table 1 Sensor use guide

Sample Material	KS-3	TR-3	SH-3	RK-3
Low-viscosity liquids (water)	BEST ¹	NO	NO	NO
High-viscosity liquids (glycerin, oil)	BEST ²	OK ²	NO	NO
Insulation and insulating materials	BEST ³	NO	NO	NO
Moist soil	OK	BEST	OK	OK
Dry soil, powders, and granular material	OK	BEST	OK	OK
Concrete and rock	NO	BEST ^{4,6}	OK ⁵	BEST ^{4,6}
Other solids	NO	BEST ⁴	OK ⁵	OK ⁴
Volumetric specific heat capacity	NO	NO	BEST	NO
Thermal diffusivity	NO	NO	BEST	NO

¹ In low-viscosity liquids operate in low-power mode to avoid free convection and avoid any vibration of the sample. Some users have found good results by placing the TEMPOS in unattended mode, reading every 15–30 min, and leaving it to read overnight. The lowest readings obtained are those without convection.

² In high-viscosity liquids, only use the KS-3 or TR-3 in low-power mode.

³ The KS-3 in default mode (low-power, 1-min read).

⁴ In solid materials where a pilot hole has been drilled and contact resistance can be significant, use thermal grease.

⁵ The SH-3 sensor takes accurate measurements in rock and cured concrete, but it is very difficult to drill small diameter, parallel holes in these materials to accommodate the SH-3 needles.

⁶ The TR-3 is generally more accurate than the RK-3 sensor and should be used if possible. However, it is extremely difficult (or impossible) to drill a long, thin hole into cured concrete and rock samples to accommodate the TR-3. The TR-3 also comes with pilot pins for use in wet concrete or fluidized backfill.

Each sensor is available for individual sale when purchasing a TEMPOS controller.

2.3.1 KS-3

The small (60-mm long, 1.3-mm diameter), single-needle KS-3 sensor measures thermal conductivity and thermal resistivity. The KS-3 works best for liquid samples and insulating materials (thermal conductivity < 0.1 W/(m • K)). In low-power mode this sensor applies a very small amount of heat to the needle, which helps to prevent free convection in liquid samples and melting in frozen samples. This sensor also works well for soils and other porous materials, but its small size makes it more susceptible to damage in materials when insertion is difficult.

High-power mode is recommended for high thermal conductivity materials (soils). Low-power mode is best for insulation, liquids, and frozen materials.

2.3.2 TR-3

The large (100-mm long, 2.4-mm diameter), single-needle TR-3 sensor measures thermal conductivity and thermal resistivity. The TR-3 is primarily designed for soil and other granular or porous materials. In harder samples, appropriately sized holes can be created using drill bits or pilot pins ([Section 3.1](#)).

The larger diameter of the TR-3 makes it more robust than the KS-3 and less likely to be damaged in normal use in soil or other solid materials. Additionally, the dimensions of the TR-3 sensor conform to the specifications for the Lab Probe called out by the IEEE 442-1981, Guide for Soil Thermal Resistivity Measurements, and ASTM D5334, Standard Test Method for Determination of Thermal Conductivity of Soiled and Soft Rock by Thermal Needle Probe Procedure.

When the TR-3 is in 1-min reading mode, it heats for 1 min and concurrently records temperature measurements. The temperature measurements are taken at 1-s intervals. When in 5- or 10-min measurement mode, the TR-3 heats for half the time and cools for the other half of the time. Temperature measurements are taken every 2 s.

NOTE: Despite its durability, the TR-3 needle can be bent with enough applied force, and although the TR-3 comes with drill bits for pilot holes, drilling straight holes in solid materials like rock and concrete is very difficult. Consider using the RK-3 for applications involving solid rock and concrete.

2.3.3 SH-3

The dual-needle (35-mm long, 1.3-mm diameter) SH-3 sensor measures volumetric heat capacity, thermal diffusivity, thermal conductivity, and thermal resistivity. The SH-3 is compatible with most solid and granular materials, but operators should not use it in low viscosity liquids because of the large heat pulse and resulting free convection in liquid samples. It can also be used in foods because of its smaller size.

The SH-3 runs for 2 min. It heats for 30 s, measures temperature for 1.5 min, and concurrently records the temperature measurements it makes. The temperature measurements are taken at 1-s intervals.

NOTE: For best accuracy, keep the needles parallel to each other. The spacing between the needles is 6 mm.

2.3.4 RK-3

The thick (60-mm long, 3.9-mm diameter), single-needle RK-3 sensor measures thermal conductivity and thermal resistivity and was designed specifically for use in hard materials like rock or cured concrete, where a rotary hammer must be used to drill a hole to accommodate the sensor. The TR-3 sensor is typically more accurate than the RK-3 sensor and is the preferred choice in granular and solid materials as long as a tight hole can be made to accommodate the longer and thinner sensor. In instances where the material is too hard to drill a hole for the long, thin TR-3 sensor, a 5/32-inch (4-mm) rotary hammer bit (included in the RK-3 Rock Sensor Package) can be used to drill a pilot hole in the material. Make sure to remove any dust or drill cuttings from the rotary

SYSTEM

hammer hole using a swab or compressed air before inserting the RK-3 sensor. It is also necessary to use the thermal grease included to ensure good thermal contact between the RK-3 sensor and the test material.

NOTE: Do not use the RK-3 sensor in liquid samples.

3. OPERATION

Please read all of the instructions before operating the TEMPOS to ensure it performs to its full potential.

⚠ PRECAUTIONS

METER sensors are built to the highest standards, but misuse, improper protection, or improper installation may damage the sensor and possibly void the manufacturer's warranty. Before integrating TEMPOS or other METER sensors into a system, make sure to follow the recommended installation instructions and have the proper protections in place to safeguard sensors from damage.

3.1 CONTROLLER CONFIGURATION

The controller must first be configured through Device Configuration. [Figure 1](#) provides a sample of the Device Configuration menu on the TEMPOS controller.

1. When the TEMPOS controller is first turned on, a message requesting time and date verification appears ([Figure 12](#)).

NOTE: The Time and Date verification is only required after the unit has been completely powered down or if the batteries have died or been removed. Time and date verification is not required when the controller goes to sleep after 5 min of inactivity. To wake the unit back up, press the POWER button once.

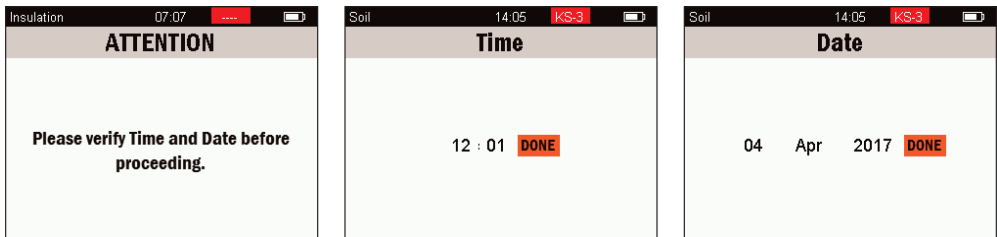

Figure 12 Verify time and date

2. On the Main menu, highlight the Device Configuration icon.
3. Press the **CENTER** button.
4. Update the configuration settings as desired.

[Table 3](#) contains a list of the customization options available to choose from on the Device Configuration menu.

Table 2 Device Configuration menu options

Options	Action
Time	Set the current time
Date	Set the current date
Units	Choose the measurement units to be displayed Choose between SI or Imperial units
Language	Choose between the following languages: English, Deutsch, Français, Italiano, Español, Polski, and Nederlands
Hour format	Switch between the 12-h and 24-h clock
Brightness	Set the brightness Brightness can be set between 0% and 100%

5. Press the **BACK** button to return to the Main menu.

3.2 MEASUREMENT CONFIGURATION

Before taking a reading, the TEMPOS controller must be configured to reflect the desired reading type.

1. From the Main menu, navigate to the Measurement Configuration icon (Figure 3).
2. Press the **CENTER** button.

The Measurement Configuration screen (Figure 13) will open.

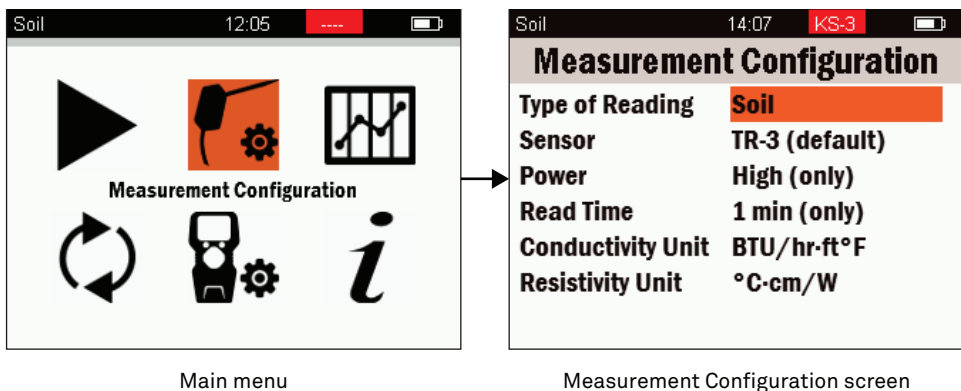

Figure 13 Measurement Configuration screen

3. Highlight and select the Type of Reading field.

The Select Type of Reading screen (Figure 14) will open. Within this menu, specialized configurations for specific materials and applications can be chosen (Table 3). Additional custom-configuration options for readings are also available.

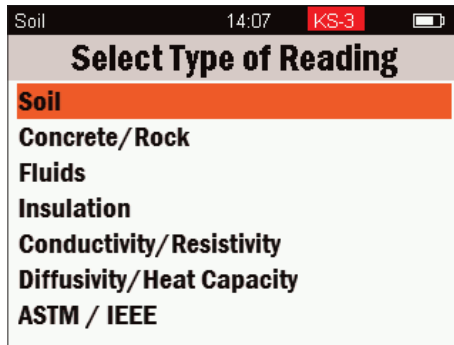

Figure 14 Select Type of Reading menu

Table 3 Measurement Configuration menu options

Mode	Setting Description
Soil	<p>For measurements made in intermediate conductivity porous materials such as soils.</p> <p>Compatible with all TEMPOS sensors except SH-3.</p> <p>Uses only high-power mode.</p> <p>Read time is 1 min.</p> <p>Computes thermal conductivity (K) and thermal resistivity (ρ) from proprietary advanced algorithms.</p>
Rock/concrete	<p>For measurements in rock and cured concrete.</p> <p>Compatible with RK-3 and TR-3 sensors.</p> <p>Uses only high-power mode.</p> <p>Read time is 1 min.</p> <p>Computes thermal conductivity (K) and thermal resistivity (ρ) from proprietary advanced algorithms.</p>
Fluids/liquids	<p>For measurements in fluids.</p> <p>Compatible with KS-3 sensor.</p> <p>Uses low-power mode.</p> <p>Read time is 1 min.</p> <p>Computes thermal conductivity (K) and thermal resistivity (ρ) from proprietary advanced algorithms.</p>

Table 3 Measurement Configuration menu options (continued)

Mode	Setting Description
Insulation	Used for low thermal conductivity materials like insulation.
	Compatible with KS-3 sensor.
	Uses low-power mode.
	Read time is 1 min.
Conductivity/ resistivity	Computes thermal conductivity (K) and thermal resistivity (ρ) from proprietary advanced algorithms.
	Similar to previous modes, but allows more flexibility in use of sensors and settings.
	Compatible with all TEMPOS sensors except SH-3.
	Uses either low or high heat-power mode.
Diffusivity/ heat capacity	Read time is 1 min.
	Computes thermal conductivity (K) and thermal resistivity (ρ) from proprietary advanced algorithms.
	Used with the dual needle sensor to measure conductivity, diffusivity, and heat capacity of a sample.
	Compatible with SH-3 sensors.
ASTM/IEEE	Uses high-power mode.
	Read time is 2 min.
	Computes thermal conductivity (K), diffusivity (D), and volumetric specific heat capacity (C) from proprietary advanced algorithms.
	For measurements on soils, rock, and concrete when the older, less accurate ASTM/IEEE specifications must be followed.
ASTM/IEEE	Compatible with all TEMPOS sensors except the SH-3.
	Uses high-power mode.
	Read time is either 5 or 10 min. The TR-3 needle and a 10-min read time are consistent with the IEEE 442-1981 specification.
All single-needle probes meet the ASTM D5334 specification.	

NOTE: To make thermal diffusivity and specific heat (volumetric specific heat capacity) readings, please use the Diffusivity/Heat Capacity mode in conjunction with an SH-3 sensor.

- Navigate to the desired type of reading from the Select Type of Reading menu (Figure 14).
- Press the **CENTER** button.
- Review the default settings.
- If no changes need to be made, press the **BACK** button to return to the Main menu. To change defaults, continue to [step 8](#).

8. Select the desired field.
9. Use the D-pad to scroll through and select the options that are compatible with the chosen type of reading.
The options for each setting are preconfigured based on the reading type chosen.
10. Press the **BACK** button to return to the Measurement Configuration menu.
11. Press the **BACK** button to return to the Main menu.

3.3 SENSOR INSTALLATION

METER designed all four TEMPOS sensors for ease of installation and use. To install sensors, insert the sensor needle(s) all the way into the sample material. Some materials are more difficult than others to get the needle(s) inserted. Please observe the following considerations when installing the sensors.

- Allow a minimum of 1.5 cm of material parallel to the sensor in all directions to avoid errors. Materials with a high thermal conductivity will require a larger sample size.
- Make sure that the sensor fits tightly into the hole.
- Insert the sensor needle all the way into the sample material.
- Use the thermal grease (included in kit) to improve contact in hard or grainy samples.
- The needles on the SH-3 dual-needle sensor must remain parallel to each other during insertion to make an accurate reading. Use the SH-3 needle guide (Figure 15) when making pilot holes to ensure that the needles have the correct spacing.



Figure 15 SH-3 needle guide for pilot holes

Bending the needles can damage any sensor beyond repair. If the needle becomes bent, gently bend it back. If a needle has been bent and is no longer taking good readings, a replacement may be needed. Contact [Customer Support](#) for a replacement.

NOTE: The following subsections list specific installation protocol for unique situations. All other situations are covered by the generic instructions listed above.

3.3.1 ROCK OR CURED CONCRETE (RK-3)

Follow the steps below to install a sensor into rock or cured cement.

CAUTION: METER recommends the user wear safety goggles and use care when drilling into rock or cured cement.

1. Drill a 4-mm (5/32-in) hole with a rotary hammer.
2. Clean the hole with a swab or compressed air.
3. Before inserting sensor needle, put thermal grease into the hole.
4. Ensure the sensor fits tightly into the hole.

Good thermal contact between the sensor and the measured medium is critical for accurate measurements.

3.3.2 WET CEMENT

Use the following steps to install a pilot pin into wet cement. This will allow the sensor needle to be inserted later into the cured cement without damage to the sensor needle or the cement.

1. Coat the pilot pin with petroleum jelly.
2. Insert the pilot pin into the wet cement.
3. Ensure enough of the pin is showing to be able to grip it for removal.
4. Ensure the pilot pin is deep enough that the needle can be entirely inserted once the concrete has cured (Figure 16).

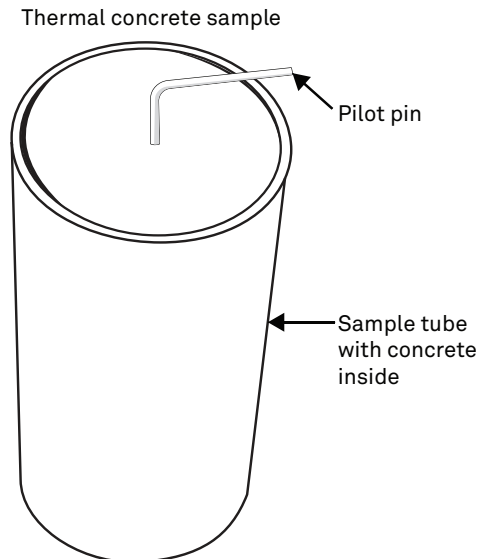

Figure 16 Pilot pin used to form TR-3 access hole

3.3.3 SOLID MATERIAL (TR-3)

Use the following steps to install a sensor into solid materials, such as wood or hard soil.

1. Drill a pilot hole using the 2.40-mm (0.945-in) drill bit included for the TR-3 sensor in solid material.
2. Clean the hole with a swab or compressed air.
3. Before inserting sensor needle, put thermal grease into the hole.
4. Ensure the sensor fits tightly into the hole.

3.4 TAKE A READING

Before taking a reading, plug the sensor into the TEMPOS controller using the DB-15 connector.

NOTE: For information on using Unattended Mode to take readings in go to [Section 2.2.5](#).

Contact [Customer Support](#) for assistance in taking measurements in unique materials not covered in this manual.

1. In the Reading screen, press the **CENTER** button to select Start Reading.

NOTE: If in Insulation Reading mode, the reader will prompt for the thickness at the end of the reading.

To abort a reading at any time, push the **CENTER** button of the D-pad. Aborting the reading will return to the Take a Reading screen.

2. The sensor will equilibrate for 30 s ([Figure 17](#)).
3. Review temperature drift.
 - a. If the temperature drift is <0.002 °C/s, the instrument will automatically enter the active heating mode.
 - b. If the temperature drift is >0.002 °C/s, an error reading will appear.
 - i. Select to either equilibrate for an additional 30 s or continue with the reading and risk recording a high-temperature-drift reading.
 - ii. If no option is selected, the device will complete two additional 30-s equilibration cycles and automatically start a reading.

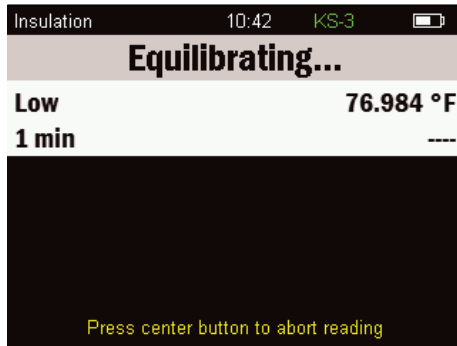
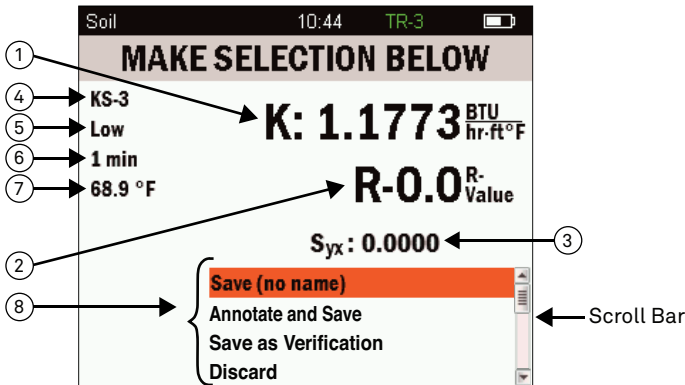

Figure 17 Equilibrating screen

4. The message COMPLETE! is briefly flashed in the title bar at the end of the reading before displaying the data on the Make Selection Below screen (Figure 18).



- ① **Calculated thermal measurement and units.** The letter to the left of the reading indicates the type of reading.
 K = thermal conductivity D = thermal diffusivity
 C = volumetric specific heat capacity ρ = thermal resistivity
- ② **R-Value** is the capacity of an insulating material to resist heat flow. The higher the R-value, the greater the insulating power.
- ③ **S_{yx}** stands for Standard Error of the Estimate. It is an error term that quantifies how well the regression line fits the data. For more information on S_{yx} refer to [Section 4.3](#).
- ④ **Sensor name** used to take the reading.
- ⑤ **Power mode** used (high or low).
- ⑥ **Read time.**
- ⑦ **Temperature** at the beginning of the reading.
- ⑧ **Title bar** reads MAKE SELECTION BELOW, prompting user to choose how to save the data. All four options (Save (no name), Annotate and Save, Save as Verification, and Discard) do not show up on screen (but are shown in the image above). Use the scroll bar to see the options that do not show.

Figure 18 Make Selection Below screen

3.5 SAVING AND VIEWING A READING

At the end of a test, the MAKE SELECTION BELOW screen will appear. On the bottom of this screen are four save options (Figure 18). Use the D-pad to scroll through the options and press the **CENTER** button to select each highlighted option.

SAVE (NO NAME)

Save (No Name) saves the reading with the name Saved in the Stored Readings menu.

ANNOTATE AND SAVE

Annotate and Save option attaches a sample identification to the reading. Follow the instructions below to create annotations and save annotations.

1. Use the D-pad to highlight and select the desired characters. The maximum character length is 20 characters.

Use the Insert Shift key or Insert Special Characters key to change keyboards.

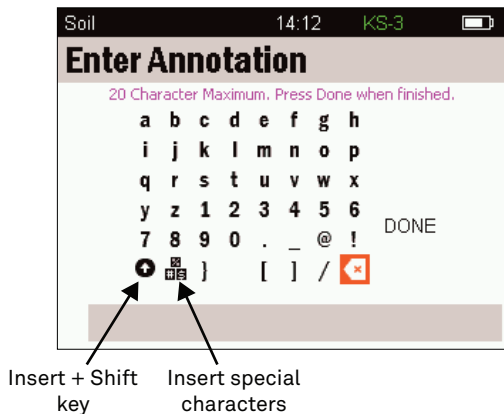

Figure 19 Enter Annotation

2. Select DONE in the Enter Annotation screen.
3. Press the **CENTER** button to save the annotation.

The cursor will be returned to the initial Reading screen after saving, where the latest reading will be displayed.

SAVE AS VERIFICATION

Save as Verification tags readings using the verification standard to ensure correct functioning of the device. There will be a preset text verification or V in the Tag field. This screen also allows an annotation to be added to a reading. When finished, select DONE to return to the Reading screen, where the last reading taken will be displayed.

DISCARD

Select Discard to continue without saving the reading.

NOTE: Once a reading has been discarded, it cannot be retrieved.

3.6 INTERFACING WITH TEMPOS UTILITY

TEMPOS Utility is a free download utility available from metergroup.com. It is used to download data from the TEMPOS controller and enables the user to analyze data in a Microsoft® Excel® spreadsheet.

3.7 INSTALL TEMPOS UTILITY

To download the TEMPOS Utility, follow the directions below.

NOTE: This downloader is only compatible with systems using a Microsoft Windows® 7 (or later) operating system.

1. Download the TEMPOS Utility executable file at software.metergroup.com/TEMPOSUtilityInstaller.exe.
2. Install the TEMPOS Utility and USB driver.

Once the downloader is installed, TEMPOS Utility will open a new window (Figure 20). The software can now be used to download data from TEMPOS.

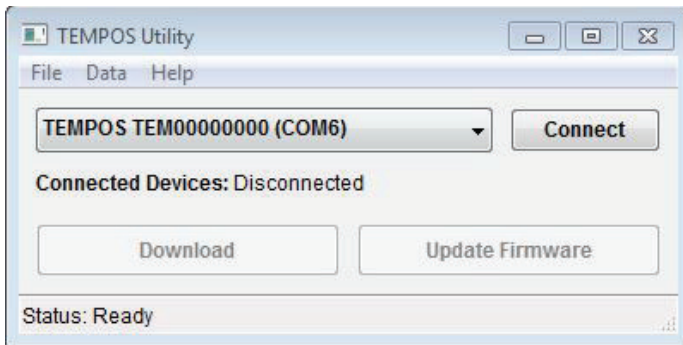

Figure 20 TEMPOS Utility downloader

3.7.1 DOWNLOAD DATA

1. Connect the TEMPOS controller to the computer using the USB cable.
2. Once connected, the controller serial number will appear in the TEMPOS Utility dropdown (Figure 20).
If more than one TEMPOS is connected via USB, each will show in the dropdown.
3. Click on the correct TEMPOS from those listed in the dropdown list.

4. Click on the Connect button.
Once connected, the options to Download or Update Firmware are available.
5. Press Download to download the data stored on the controller (Figure 20).
6. All saved data will be downloaded to an Excel spreadsheet (Figure 21) that will automatically open.
 - a. Data displayed in a Microsoft Excel spreadsheet (Figure 21) are organized by columns. Each measurement occupies its own column.
 - b. Rows 1–12 display information found on the Measurement Finished Screen (Figure 19).
 - c. Row 13 provides the amount of power, in Watts, applied to the sensor during the reading. The majority of the rows are temperature measurements.
 - d. Teq#s are temperatures recorded during equilibration and T#s are temperatures recorded during the heating or cooling phase.
 - e. The final rows are tags indicating a suspect reading or verification.

	A	B	C	D	E	F	G	H	I
1	Title	Verification	glycerin 4.1	glycerin 4.2	glycerin 4.3	glycerin TR3.1	glycerin TR3.2	glycerin KS3.1	glycerin KS3.2
2	Timestamp	01/04/18 19:08:12	01/04/18 19:12:11	01/04/18 19:27:11	01/04/18 19:42:13	01/07/18 11:27:17	01/07/18 11:42:19	01/07/18 12:00:26	01/07/18 12:15:27
3	Mode	Diffusivity/Heat Capa	Diffusivity/Heat Capa	Diffusivity/Heat Capa	Diffusivity/Heat Capa	Conductivity/Resistivi	Conductivity/Resistivi	Conductivity/Resistivi	Conductivity/Resistivi
4	Sensor	SH-3	SH-3	SH-3	SH-3	TR-3	TR-3	KS-3	KS-3
5	Power Mode	High	High	High	High	Low	Low	Low	Low
6	Read Time	Two Minutes	Two Minutes	Two Minutes	Two Minutes	One Minute	One Minute	One Minute	One Minute
7	K	0.39	0.27	0.28	0.28	0.29	0.29	0.27	0.28
8	Rho	251.13	321.97	328.09	329.27	342.24	348.23	365.89	354.54
9	R (Resistance)	2.51	3.22	3.28	3.29	0.00	0.00	0.00	0.00
10	D	0.20	0.10	0.10	0.10	0.00	0.00	0.00	0.00
11	C (Heat Cap)	1.83	2.86	2.87	2.86	0.00	0.00	0.00	0.00
12	Err	0.00	0.00	0.00	0.00	0.00	0.00	0.00	0.00
13	Power (W)	18.99	18.99	18.99	18.99	0.39	0.39	0.60	0.60
14	Teq1	22.23	22.23	22.29	22.30	20.23	20.25	20.36	20.44
15	Teq2	22.23	22.23	22.29	22.30	20.23	20.25	20.36	20.44
16	Teq3	22.23	22.23	22.29	22.30	20.23	20.25	20.36	20.44
17	Teq4	22.23	22.23	22.29	22.30	20.23	20.25	20.36	20.44
18	Teq5	22.23	22.22	22.29	22.30	20.23	20.25	20.36	20.44
19	Teq6	22.23	22.22	22.29	22.30	20.23	20.25	20.36	20.44
20	Teq7	22.23	22.22	22.29	22.30	20.23	20.25	20.36	20.44
21	Teq8	22.23	22.22	22.29	22.30	20.23	20.25	20.36	20.44
22	Teq9	22.23	22.22	22.29	22.30	20.23	20.25	20.36	20.44
23	Teq10	22.23	22.22	22.29	22.30	20.23	20.25	20.36	20.44
86	T43	23.06	22.80	22.87	22.88	20.48	20.50	20.94	21.03
87	T44	23.05	22.80	22.88	22.89	20.49	20.50	20.95	21.03
88	T45	23.04	22.81	22.88	22.89	20.49	20.50	20.95	21.03
89	T46	23.03	22.81	22.88	22.89	20.49	20.50	20.95	21.04
90	T47	23.02	22.81	22.89	22.90	20.49	20.51	20.96	21.04
91	T48	23.01	22.81	22.89	22.90	20.49	20.51	20.96	21.04
92	T49	23.00	22.81	22.89	22.90	20.50	20.51	20.97	21.05
93	T50	22.99	22.81	22.89	22.90	20.50	20.51	20.97	21.05
94	T51	22.98	22.81	22.89	22.90	20.50	20.51	20.97	21.05
95	T52	22.97	22.81	22.89	22.90	20.50	20.52	20.98	21.06
96	T53	22.96	22.81	22.89	22.90	20.50	20.52	20.98	21.06
97	T54	22.95	22.81	22.89	22.90	20.51	20.52	20.98	21.07
98	T55	22.94	22.81	22.89	22.90	20.51	20.52	20.99	21.07
99	T56	22.93	22.81	22.89	22.90	20.51	20.52	20.99	21.07
100	T57	22.93	22.81	22.89	22.90	20.51	20.52	20.99	21.07
101	T58	22.92	22.81	22.89	22.90	20.51	20.53	20.99	21.08
102	T59	22.91	22.81	22.89	22.90	20.51	20.53	21.00	21.08
103	T60	22.90	22.81	22.88	22.89	20.52	20.53	21.00	21.08
104	Reading Suspect								
105	Reading Suspect								
106	Reading Suspect								
107	Supplied Standard	X	X	X	X	X	X	X	X
108	Unattended Mode								

Figure 21 Sample downloaded data

7. Click on the Disconnect button.
8. Unplug the TEMPOS controller from the computer.
9. Close the TEMPOS Utility.

3.7.2 UPDATE FIRMWARE VERSION

To update the firmware version of the TEMPOS controller, follow the steps listed below:

1. Connect the TEMPOS controller to the computer using the USB cable.
2. Once connected, the controller serial number will appear in the TEMPOS Utility dropdown ([Figure 20](#)).
If more than one TEMPOS is connected via USB, each will show in the dropdown.
3. Click on the correct TEMPOS from those listed in the dropdown list.
4. Click on the Connect button.
Once connected, the options to Download or Update Firmware are available.
5. Click the Update Firmware button in the TEMPOS Utility screen ([Figure 20](#)) .
6. Click the Disconnect button.
7. Unplug the TEMPOS from the computer.
8. Close TEMPOS Utility.

4. THEORY

Transient line heat source methods have been used to measure thermal conductivity of porous materials for over 60 years. Typically, a probe for this measurement consists of a needle with a heater and temperature sensor inside. A current passes through the heater and the system monitors the temperature of the sensor over time. Analysis of the time dependence of sensor temperature, when the probe is in the material under test, determines thermal conductivity. More recently, the heater and temperature sensors have been placed in separate needles. In the dual-probe sensor the analysis of the temperature versus time relationship for the separated probes yields information on diffusivity and heat capacity, as well as conductivity.

An ideal sensor has a very small diameter and is approximately 100 times longer than its diameter. The sensor is in intimate contact with the surrounding material and measures the temperature of the material during heating and cooling. Ideally, the temperature and composition of the material in question would not change during the measurement.

Real sensors fall short of these ideals in several ways.

- A sensor small enough to be ideal would be too fragile for most applications.
- Measurements in outdoor environments involve changing temperatures; the ambient temperature generally is not constant.
- Heating moist, unsaturated porous materials causes water to move away from the heat source, thereby altering the water content in the region of measurement.
- The hole made for the probe often disturbs the material around it causing a contact resistance between the sensor and the material.

It is a challenge to design a sensor that gives accurate measurements under all conditions.

- If the sensor is too small it is fragile, and the contact resistance can be high in dry, porous materials.
- Large sensors require a long heating time, which can alter the reading by driving water away from the sensor and can cause free convection in liquid samples, thus altering the reading.
- A high-heating rate makes temperature changes easier to read and less susceptible to temperature drift errors, but results in water movement out of the measuring region and free convection in liquids. Because of this, long heating times are recommended to minimize contact resistance but they result in water movement away from the sensor.

The TEMPOS design attempts to optimize thermal properties measurements relative to these issues. METER sensors are relatively large and robust making them easy to use. The TEMPOS keeps heating times as short as possible to minimize thermally induced water movement and lower the time required for a measurement. The heat input is also limited to minimize water movement and free convection. Use of relatively short heating times and low heating rates requires high resolution temperature measurements and special algorithms to measure thermal properties. The TEMPOS resolves temperature to ± 0.001 °C and determines the rate of temperature drift prior to the measurement to correct the reading for drift.

In the past the temperature data obtained from probes like those used in TEMPOS were converted to thermal properties using an approximation to the solution for the infinite line heat source equations. In some cases this worked well, but in others the results were pretty bad. Better equations have been available for a long time. Blackwell (1954) provided an exact solution for a finite diameter heated probe with contact resistance, but it wasn't useful for analyzing time domain data because it was only in the Laplace domain. Finally, in 2012, a method was discovered that transforms Blackwell's solution to the time domain (Knight et al. 2012). That has been extensively used to produce improved algorithms for TEMPOS. Inverting the Knight et al. model requires more computing power than is available in a battery operated microprocessor, so METER generated data for a wide range of known thermal properties using the Knight et al. model and then found corrections to the line heat source based inversions that made them match the known thermal properties. Those algorithms were then checked on real samples of known thermal properties. This allows the use of short heating times and still avoid problems with contact resistance and sample diffusivity effects that were problems with the old methods. The new algorithms are described in [Section 4.1](#) and [Section 4.2](#).

4.1 DUAL-NEEDLE ALGORITHM

Heat is applied to the heated needle for a set heating time, t_h , and temperature is measured in the monitoring needle 6 mm distant during heating and during a cooling period following heating. The readings are then processed by subtracting the ambient temperature and the rate of drift. The resulting data are fit to [Equation 1](#) and [Equation 2](#) using a least squares procedure.

$$\Delta T = \left(\frac{q}{4\pi k} \right) Ei \left(\frac{-r^2}{4Dt} \right) \quad t \leq t_h \quad \text{Equation 1}$$

$$\Delta T = \left(\frac{q}{\pi k} \right) \left\{ Ei \left[\frac{-r^2}{4D(t-t_h)} \right] - Ei \left[\frac{-r^2}{4Dt} \right] \right\} \quad t > t_h \quad \text{Equation 2}$$

Where

ΔT is the temperature rise at the measuring needle,

q is the heat input at the heated needle (W/m),

k is the thermal conductivity (W/mK),

r is the distance from the heated needle to the measuring needle,

D is the thermal diffusivity (m²/s),

t is time (s), and

t_h is the heating time (s).

E_i is the exponential integral and is approximated using polynomials (Abramowitz and Stegun 1972).

The TEMPOS collects data for at least 30 s to determine the temperature drift. If the drift is below a threshold, current is applied to the heater needle for 30 s, during which time the temperature of the sensing needle is monitored. At 30 s the current is shut off and the temperature is monitored for another 90 s. The starting temperature and drift are then subtracted from the temperatures giving the ΔT values needed to solve Equation 1 and Equation 2. We know the values of q , r , t and t_h , so we can solve for k and D . This could be done using traditional nonlinear least squares (Marquardt 1963), but those methods often get stuck in local minima and fail to give the correct result. If a value is chosen for D in Equation 1 and Equation 2, the calculation becomes a linear least squares problem. We then search for the value of D that minimizes the squared differences between measured and modeled temperature. This method gives the global minimum, and, if structured correctly, is as fast as traditional nonlinear least squares. Once k and D are determined, the volumetric specific heat capacity can be computed using Equation 3.

$$\rho C = \frac{k}{D} \tag{Equation 3}$$

4.2 SINGLE-NEEDLE ALGORITHM

There are three single needle sizes:

- KS-3 is 1.2 mm in diameter and 60 mm long
- TR-3 is 2.4 mm in diameter and 100 mm long
- RK-3 is 3.9 mm in diameter and 60 mm long

As with the dual-needle sensor, the probe temperature is monitored for at least 30 s to determine the temperature drift. The start temperature and the drift are then subtracted from the measurements. Current is then run through the heater for 60 s while the probe temperature is monitored. If the needle were a line-heat source, Equation 1 could be used to predict its temperature. When Equation 1 is used for single-needle analysis, the exponential integral is expanded in an infinite series and only the first term in the expansion is retained, as shown in Equation 4. This is the equation used in the ASTM/IEEE mode.

$$\Delta T = \left(\frac{q}{4\pi k} \right) \ln t + C \tag{Equation 4}$$

This expansion is assumed to apply only at long heating times, so early time data are left out of the analysis. Equation 4 can, in fact, be shown to give correct results after long enough times, but the times are very long, especially for low-conductivity materials. Equation 4 shows that conductivity is proportional to the inverse of the slope when temperature is plotted vs. $\ln t$. At long times the temperature hardly changes, so noise in the measurements can strongly affect the measurement. Part of the problem with shorter measurement times is that the neglected terms in the exponential integral expansion are functions of diffusivity, so sample diffusivity affects the conductivity estimates. A bigger

problem, though, is that the line heat source has no heat capacity, and the real probe has significant heat capacity. Another big problem is that there is often a contact resistance between the probe and the medium in which it is placed.

To investigate these effects, the Knight et al. (2012) model was used to simulate sensor data for a wide range of conductivities, diffusivities, and contact resistances. After fitting Equation 4 to these data, it was determined that the biggest problem is in the time scale. By changing the equation to

$$\Delta T = \left(\frac{q}{4\pi k} \right) \ln(t + t_o) + C \quad \text{Equation 5}$$

where t is a time offset, all of the data fit well with heating times of 60 s. Effects of contact resistance and diffusivity are eliminated or significantly reduced. The values of k , t , and C are determined by least squares. This is another nonlinear least squares problem, which could be solved using traditional methods (Marquardt 1963). It is solved by a different iterative method, though. Values of t are supplied and the one is found that minimizes the standard error of estimate. This procedure was used on samples of known conductivity, such as glycerin and agar water, and on dry and wet soil. The 1-min readings on all of these samples were more accurate than 10-min readings using Equation 4. For all of these calculations the first 16 s of temperature data were ignored.

4.3 UNDERSTANDING THE S_{YX} VALUE

The TEMPOS displays the standard error of estimate S_{YX} to indicate how well the models in Equation 1, Equation 2, and Equation 5 fit the data. There is certainly a relationship between this value and the uncertainty in thermal properties estimates, but it is a complex one. The purpose of reporting a value is to alert the user when poor fits occur. The value depends strongly on the thermal conductivity of the material being tested. For example, it will be larger for measurements in insulation than for measurements in wet sand. It is intended as an indicator of problems, and is not directly related to errors in the thermal properties measurements. It has units of Kelvins, so a value of 0.001 indicates that the standard error of estimate for the model fit to the data is 1 mK.

5. SERVICE

This section describes the maintenance and verification of the TEMPOS sensors and controller. Troubleshooting solutions and customer service information are also provided.

5.1 SENSOR MAINTENANCE AND VERIFICATION

The stainless-steel needles can be cleaned with steel wool or other mild abrasives. The needles can even be gently straightened with a pair of pliers, if needed. Be very cautious when gently bending the needles; the heating element and temperature sensor in the needle can easily be damaged.

The TEMPOS controller makes readings based on the first principles of thermodynamics using the precise measurement of temperature to 0.001 °C. Because of this, no calibration is required.

The sensors will require periodic verification. Verification that the instrument is working correctly can be done by measuring a standard of known thermal conductivity. The TEMPOS kit ships with two standard materials that can be used to verify that the sensors are operating according to specifications:

- Clear vial of glycerin (glycerol) for the KS-3, TR-3, and RK-3 sensors.
- White plastic Delrin cylinder for the dual-needle SH-3 sensor.

Once a verification measurement has been made it can be tagged and saved as a verification ([Section 3.5](#)).

NOTE: The glycerin needs to be replaced annually and is labeled with an expiration date. Use USP-grade glycerin or order a replacement vial. Vials of glycerin and Delrin cylinders (SH-3 only) can be ordered by contacting [Customer Support](#).

5.1.1 VERIFICATION WITH THE KS-3, TR-3, OR RK-3

Use the glycerin to verify KS-3, TR-3 and RK-3 sensor performance. The cap of the vial has a septum that allows direct insertion of the needle into the vial for verification.

There are two verification jigs to be used with the glycerin verification vial. One of the jigs is intended to be used with the KS-3 needle. The second jig is for use with the TR-3 and RK-3 needles.

1. Using the white Delrin verification jig ([Figure 22](#)), insert the glycerin vial through the opening in the bottom.
Center the sensor needle into the center hole of the jig and plunge it through the septum into the vial.
2. Orient the needle vertically and turn the vial of glycerin upside down on top of the needle. Holding the vial upside down ensures that any bubbles in the glycerin float to the top and away from the needle.
The verification jig centers the needle in the vial so that it will not touch the sides of the vial.

3. Before taking a measurement in the glycerin, ensure that the system is not undergoing rapid temperature drift.

Seemingly small sources, such as the heat from holding the vial for a few seconds or the cooling from direct air conditioning flow, can decrease the accuracy of the measurement. It is best to place the needle and vial in an isothermal environment (e.g., an insulated chamber or cooler), and allow 15 min of equilibration time before taking the measurement.

NOTE: If the vial is moved or shaken while the instrument is measuring the glycerin verification standard, the readings will be adversely impacted.

4. On the TEMPOS controller, navigate to the Measurement Configuration screen (Section 3.2).
5. Choose Conductivity/Resistivity field.
6. Select the sensor type.
7. Set the power to low.
8. Leave all the other presets the same.
9. Press **BACK** to go the Main menu.
10. Select Take a Reading to take a measurement (Section 3.4).
11. At the end of the measurement, choose Save as Verification to tag the measurement with a V to indicate verification.

The thermal conductivity of the glycerin is $0.285 \text{ W}/(\text{m} \cdot \text{K})$ $20 \text{ }^\circ\text{C}$.

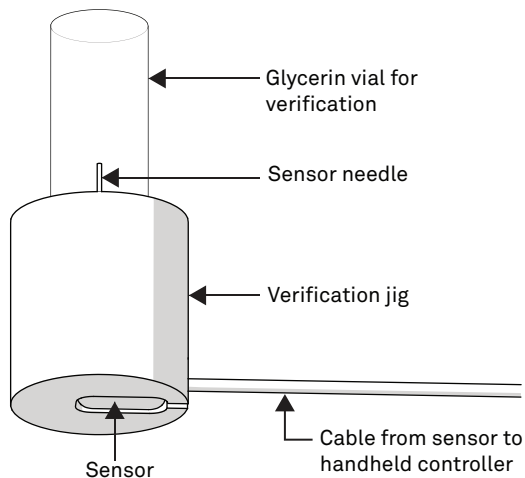

Figure 22 Verification holder for single-needle sensors

NOTE: After repeated use, the septum may begin to leak. METER provides replacement septums with the instrument. To replace, simply remove the cap, press the old septum out, and replace with a new one.

12. Compare the reading of the value recorded on the Certificate of Quality Assurance (included in the TEMPOS kit) to the results from the verification reading. For the sensor to be reading accurately, the measurements must be within $\pm 10\%$ of the glycerin standard.

5.1.2 VERIFICATION WITH THE SH-3

Use the two-hole, white Delrin block to verify the performance of the dual-needle (SH-3) sensor.

1. Fully insert the SH-3 sensor into the predrilled holes in the Delrin block.
2. Allow it to equilibrate for at least 15 min before taking the measurement.

The Delrin blocks have slightly different thermal conductivities from lot to lot, so the correct values for K , C , and D specific for individual Delrin block are recorded on the Certificate of Quality Assurance (included in the TEMPOS kit). Each block is matched with a specific SH-3 sensor.

NOTE: Holding or touching the Delrin block before or during the measurement will induce a temperature drift and may adversely impact the reading.

3. Compare the value recorded on the Certificate of Quality Assurance (included in the TEMPOS kit) to the results from the verification reading. For the sensor to be reading accurately, the measurements must be within $\pm 10\%$ of the Delrin standard.

5.2 CONTROLLER MAINTENANCE

The TEMPOS controller maintenance requires replacing the batteries. A low-battery alert will appear on the screen. The TEMPOS controller requires five alkaline AA batteries. Follow the steps below to change the batteries:

1. Turn the TEMPOS controller over and locate the battery cover in the lower section of the back panel (Figure 23).

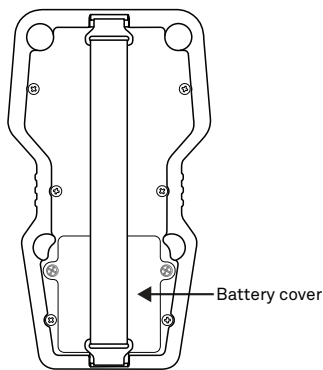

Figure 23 Battery cover

2. Using a Phillips head screwdriver, unscrew the two Phillips head screws from the right and left sides of the battery box cover.

3. Gently pull the cover from the top to expose the battery compartment.
The battery receptacles to the right and left have two batteries each, while the center receptacle only has one battery.
4. Remove the old batteries.
5. Insert new batteries, orienting them according to the polarity marks shown in the case.
6. Replace the cover and return the screws.
7. Turn on the TEMPOS controller.
8. Update the time and date as prompted.

If the TEMPOS controller should ever require servicing, please contact [Customer Support](#).

5.3 TROUBLESHOOTING

The TEMPOS controller will give two error messages described in [Table 4](#).

Table 4 Troubleshooting the TEMPOS

Problem	Possible Solutions
Low battery	Replace the batteries using the instructions in Section 5.2 .
The sensor does not match the configuration	Correct the configuration using the instructions in Section 3.2 .

Sensor failure attributed to abuse is the greatest source of inaccuracy in the system. This failure may not be visible and will only be detected by running a verification test ([Section 5.1](#)). While testing the verification standard, note signs that may indicate a problem with the heating of the sensor.

The following situations may indicate sensor failure. No significant increases in height of the red progress bars indicating a rise in temperature.

- A slight rise in temperature measurements between the beginning and end of the reading.
- A zero or negative temperature reading.
- Any unexpected temperatures based on the prevailing conditions during the measurement.

Please contact [Customer Support](#) if any of these situations are observed.

5.4 CUSTOMER SUPPORT

Customer service representatives are available for questions, problems, or feedback Monday through Friday, 7 am–5 pm Pacific time.

Email: support.environment@metergroup.com
sales.environment@metergroup.com

Phone: +1.509.332.5600

Fax: +1.509.332.5158

Website: metergroup.com

If contacting METER by email, please include the following information:

Name	Email address
Address	Instrument serial number
Phone	Description of the problem

NOTE: For TEMPOS Thermal Property Analyzers purchased through a distributor, please contact the distributor directly for assistance.

5.5 TERMS AND CONDITIONS

By using METER instruments and documentation, you agree to abide by the METER Group, Inc. USA Terms and Conditions. Please refer to metergroup.com/terms-conditions for details.

REFERENCES

- Abramowitz M, Stegun IA. 1972. Handbook of mathematical functions. New York (NY). Dover Publications, Inc.
- Blackwell JH. 1954. A transient-flow method for determination of thermal constants of insulation materials in bulk. *J. Appl. Phys.* 25:137–144.
- Bristow KL, White RD, Kluitenberg GJ. 1994. Comparison of Single and Dual Probes for Measuring Soil Thermal Properties with Transient Heating. *Australian Journal of Soil Research*, 32:447–464.
- Bruijn PJ, van Haneghem IA, Schenk J. 1983. An improved non-steady state probe method for measurements in granular materials. Part 1: Theory, High Temperatures High Pressures, 15:359–366.
- Carslaw HS, Jaeger JC. 1959. *Conduction of Heat in Solids*, 2nd Edition. Oxford, London.
- Kluitenberg GJ, Ham JM, Bristow KL. 1993. Error analysis of the heat pulse method for measuring soil volumetric heat capacity, *Soil Sci. Soc. Am. J.* 57:1444–1451.
- Knight JH, Kluitenberg GJ, Kamai T, Hopmans JW. 2012. Semianalytical solution for dual-probe heat-pulse applications that accounts for probe radius and heat capacity. *Vadose Zone Journal*. 11(2).
- Marquardt DW. 1963. An algorithm for least-squares estimation of nonlinear parameters. *J. Soc. Indust. Appl. Math.* 11:431–441.
- Shiozawa S, Campbell GS. 1990. Soil Thermal Conductivity. *Remote Sensing Rev.* 5:301–310.
- van Haneghem IA, Schenk J, Boshoven HPA. 1983. An improved non-steady state probe method for measurements in granular materials. Part II: Experimental Results. *High Temperatures High Pressures.* 15:67–374.

INDEX

A

about screen 6, 13
 accuracy 3–4
 KS-3 3
 RK-3 3
 SH-3 3
 TR-3 3
 annotate 12, 25

B

batteries 1, 12, 17
 life span 2
 status 4
 best practices 14–16

C

clock
 See time
 conductivity
 See specifications, conductivity
 contact resistance 9, 14, 29–32
 customer support 37

D

data
 downloading 26–28
 erasing 10
 saving 24–25
 storage capacity 2
 viewing 9–10
 date
 initial start 17
 of reading 11
 device configuration 17–18
 menu 6
 diffusivity
 See specifications, diffusivity
 download 26–28
 D-pad 4, 5, 9, 10, 12, 21, 23, 25–26

E

email address 37
 equilibration 23, 27, 34
 erase 9, 10
 error 10
 Syx 11, 24, 32

F

fax number 37
 firmware 6
 update 27, 28
 version 13
 fluids
 See liquids

H

heating time 8, 29–32

K

keypad
 See D-pad

L

liquids 8, 14, 15, 29

M

measuring units 8, 11, 18, 24
 memory
 capacity 2, 9
 menus
 device configuration 10, 17–19
 main menu 6
 measurement configuration 18–21
 stored readings 6, 9, 25
 unattended mode 5, 6, 10, 11, 14

P

phone number 37
 power mode 14, 19–20, 24

R

readings
 best practices 19–20, 25
 read time 19–20, 24
 references 38
 resistivity
 See specifications, resistivity
 Rock Sensor kit (RK-3) 1
 R-value 11, 23

S

sample
 See sensors, installation
 types 14
 screen 5
 brightness 18
 sensors
 accuracy 3
 cleaning 33
 installation 21
 types 14–16
 verifying performance
 KS-3 33–34
 RK-3 33–34
 SH-3 35
 TR-3 33–34
 service
 controller 36
 sensors 33
 software 26
 specifications
 conductivity 3
 controller 2
 diffusivity 3
 KS-3 sensors 3
 resistivity 3
 RK-3 sensor 3
 SH-3 sensor 3
 TR-3 sensor 3
 volumetric specific heat capacity 3

T

taking a reading 21–23
 TEMPOS Utility 26–27
 terms and conditions 37–38
 theory 29–32
 dual-needle algorithm 30–31
 error 32
 single-needle algorithm 31–32
 time 4, 17
 setting 18
 troubleshooting
 controller 36
 sensors 36

V

view reading 24–25
 results 9–10
 volumetric specific heat capacity
 See specifications, volumetric specific heat capacity

W

warranty 17

METER Group, Inc. USA
2365 NE Hopkins Court
Pullman, WA 99163
T: +1.509-332-5600 F: +1.509.332.5158
E: info@metergroup.com
W: www.metergroup.com

